

# INSTRUCTION BOOK

## Convertible Child Restraint

Series No.: BL7A/2010



**IMPORTANT:**

**KEEP THIS BOOKLET IN THE PLACE PROVIDED ON THE CHILD RESTRAINT**

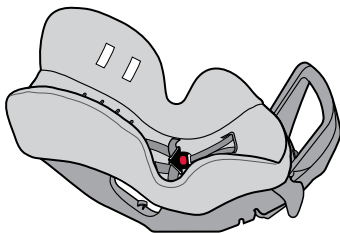

### **Rearward Facing**

For use with children  
up to approximately 6 months.

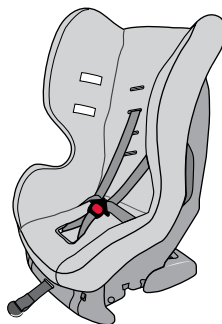

### **Forward Facing**

For use with children from approximately  
6 months to approximately 4 years of age.



Check that this child restraint will fit in your car.  
Product features and decoration may vary from images & illustrations.

## PAGE

3	INTRODUCTION
4	WARNINGS
6	SHOULDER HEIGHT MARKERS & A GROWING CHILD
7	SHOULDER HEIGHT MARKERS & THE NEXT STEP
	<b>REARWARD FACING - BABY USE</b>
9	FEATURES: REARWARD FACING
11	SUITABLE FOR USE: REARWARD-FACING
12	HOW TO SET-UP
16	HOW TO INSTALL
22	HOW TO USE
	<b>FORWARD FACING- TODDLER USE</b>
26	FEATURES: FORWARD FACING
28	SUITABLE FOR USE: FORWARD-FACING
29	HOW TO SET-UP
33	HOW TO INSTALL
38	HOW TO USE
	<b>GENERAL INSTRUCTIONS</b>
41	CARE AND MAINTENANCE
44	ACCESSORIES & FEATURES
47	TRAVELLING TIPS
48	PRE INSTALLATION ANCHOR FITTING
52	IN CASE OF CRASH

To be used only in a rearward-facing position for an infant until their shoulders reach the lower shoulder height marker (approximately 6 months of age). Then to be used in a forward-facing position until their shoulders reach the upper shoulder height marker (approximately 4 years of age).

Continue to use this child restraint until the child reaches this limit.

Do not use forward facing until child's shoulders are above the lower shoulder height marker.

Infants are at risk of serious injury if they face forward too early.

Children are at risk of serious injury if they move to booster seats too early.

Children that have outgrown this restraint are safest in a booster seat until their shoulders reach the upper shoulder height marker of the booster seat.

CAREFULLY READ ALL THE INSTRUCTIONS FOR INSTALLATION. IN THE EVENT OF DOUBT ABOUT THE METHOD OF INSTALLATION, CONSULT BABYLOVE OR AGENT OR A CHILD RESTRAINT FITTING STATION AUTHORISED BY A RELEVANT TRANSPORT AUTHORITY OR, IN NEW ZEALAND, THE AGENT FOR THE VEHICLE.

No child restraint can guarantee absolute protection from injury in every crash. However, to ensure that your child gets all the protection designed into the restraint PLEASE READ AND FOLLOW THESE INSTRUCTIONS EXACTLY and use only Babylove recommended parts and accessories.

THIS RESTRAINT MUST BE ATTACHED TO A CHILD RESTRAINT ANCHORAGE POINT IN THE CAR. REFER TO CAR OWNER'S HANDBOOK FOR LOCATION OF ANCHORAGE POINTS. REFER TO A CHILD RESTRAINT FITTING STATION IF NO ANCHORAGE POINTS ARE IN THE MOTOR CAR.

THIS RESTRAINT IS NOT SUITABLE FOR USE WHERE THE ANCHORAGE STRAP MAY FALL INTO A SPLIT IN THE SEAT BACK (E.G. HATCHBACK OR WAGON).

Always store the instruction book in the pocket provided at the back of the cover.

 **WARNINGS**

- Use the restraint exactly as shown in the instructions.
- Fit the restraint firmly to the car seat.
- Fit the harness firmly to the child.
- A loose restraint or harness is dangerous.
- Supervision of children is needed because they may be able to undo buckles and adjusters.
- **DO NOT LEAVE CHILDREN UNATTENDED IN THE CAR.**
- Do not alter or modify this restraint.
- Repairs must only be done by the manufacturer or agent.
- Do not allow the restraint to come into contact with polishes, oils, bleach and other chemicals.
- Destroy the restraint if it has been in a severe crash, even if no damage is visible.
- Do not use this restraint without a cover.
- Regularly check the restraint components, straps & other fitments for correct function and condition. Seek prompt repair.
- To ensure baby's back is evenly supported do not put more than one nappy on the baby and make sure the nappy is not thickly folded at the back.
- **DO NOT USE A REAR-FACING CHILD RESTRAINT WHERE AN AIRBAG IS FITTED IN THE FRONT OF THE SEATING POSITION.**
- If an airbag is fitted in the desired seating position where the child restraint is to be fitted, follow the vehicle manufacturer's warnings and instructions.
- **THIS RESTRAINT IS NOT SUITABLE FOR USE WHERE THE ANCHORAGE STRAP MAY FALL INTO A SPLIT IN THE SEAT BACK (E.G. HATCHBACK OR WAGON).**
- The restraint should not be purchased or sold as a second hand item. It is recommended not to use child restraints older than 10 years as the protection in an accident may be reduced.

 **WARNINGS**

- The restraint is not intended to be a substitute baby cot or bed. It is only designed to enable safe transportation of children in motor vehicles. Do not leave a baby in the restraint for long periods of time.
- Upper anchorage straps and extension straps may be damaged by unsecured cargo in a collision. Secure or remove hazardous cargo before using this strap. **Hatchback or wagon:** Do not use the child restraint where the upper anchorage strap may fall into a split in the seat back.
- Protect all webbing from abrasion and cutting by sharp corners and edges.
- Do not store in areas that may get hot, like in car boots, roof space, beside shed walls which get hot in summer. Do not place heavy items on top of the seat as this may distort the plastic.

 **WARNING:**

**DO NOT LEAVE CHILDREN UNATTENDED IN THE CAR.**

# SHOULDER HEIGHT MARKERS & A GROWING CHILD

# SHOULDER HEIGHT MARKERS & THE NEXT STEP

## NEWBORN (REARWARD FACING)

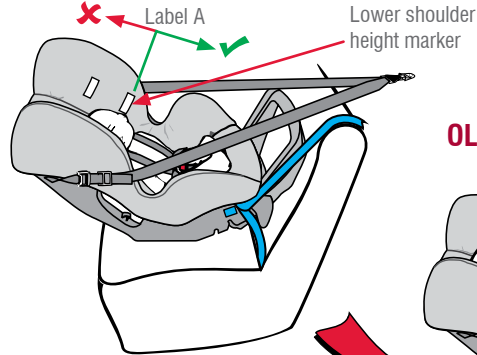

## OLDER BABY (REARWARD FACING)

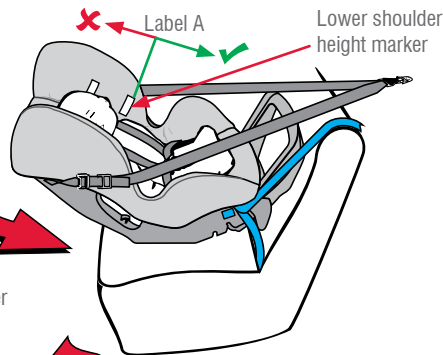

## TODDLER USE (FORWARD FACING)

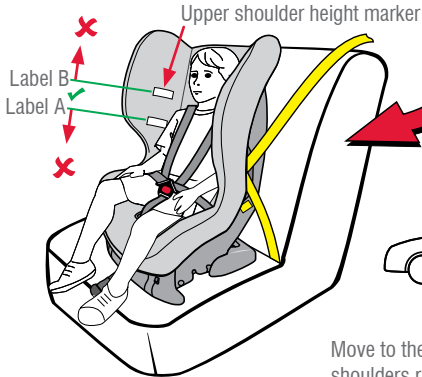

Turn to forward-facing when the child's shoulders reach the lower shoulder height marker.

Move to the next form of child restraint when the child's shoulders reach the upper shoulder height marker.

Shoulder height markers are provided on this restraint for a visual indication that the child is safe to ride in this restraint. Do not turn to forward-facing until the child's shoulders reach the lower marker. Do not continue to use the restraint if the child's shoulders are above the top marker.

**! IMPORTANT: FOLLOW THIS ADVICE.**

## LOWER SHOULDER HEIGHT MARKER : Label A

When the child's shoulders reach the lower marker, the child restraint must be turned to face towards the front of the vehicle or move the child to another Rearward or Forward Facing seat with in built harness. Approximately 6 months of age.

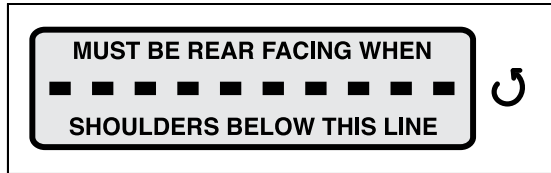

## UPPER SHOULDER HEIGHT MARKER : Label B

When the child's shoulders reach this upper marker, the child is now too big for the child restraint. It is now time to move to the next child restraint. Approximately 4 years of age.

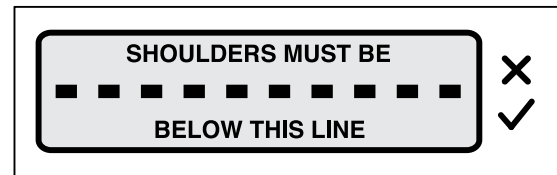

### For the next child restraint choose from:

These options are generally from approximately 4 years of age.

- Convertible Booster Seat ( Note: you can move to a convertible booster seat once the child's shoulders reach the lower shoulder height marker), this will be a little lower than the Lower Shoulder Height Marker on the child restraint covered on previous pages.

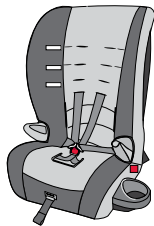

OR

- Booster Seat and an accessory Child Harness (A Child Harness must be used with a Booster Seat if the car is fitted with a lap only seat belt in the desired seating position),



OR

- Booster seat and lap-sash seat belt.

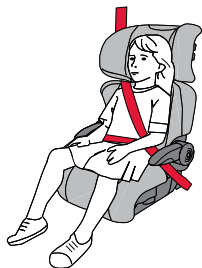

To be used only in a rearward-facing position until the infant's shoulders reach the lower shoulder height marker (approximately 6 months of age).

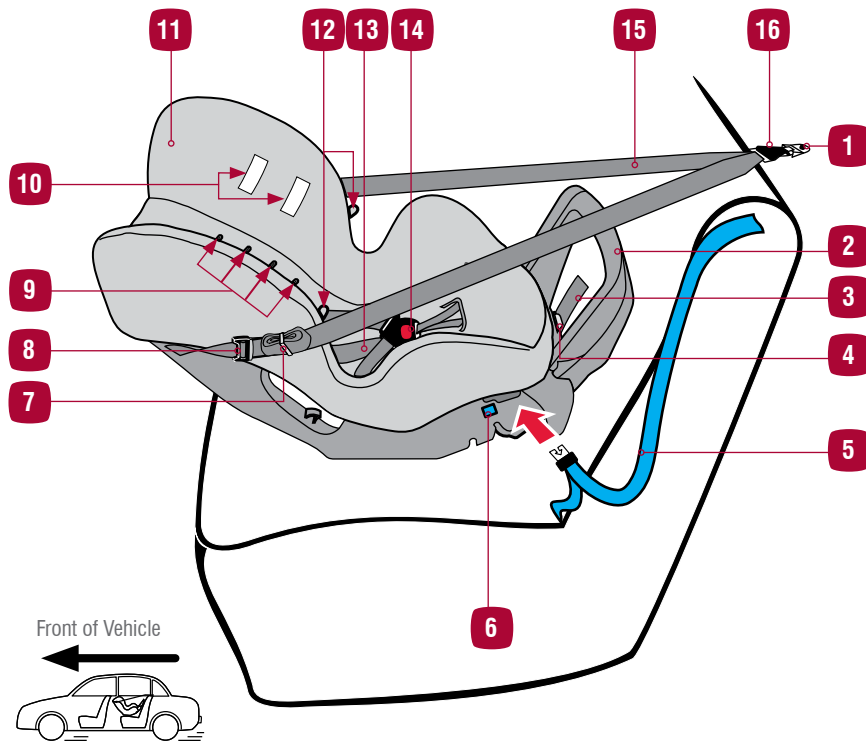

## SPECIAL FEATURES: REARWARD-FACING

### BABY USE REARWARD FACING

- 1 Car's Anchor Fitting
- 2 Stabilising Bar (Shown in Baby Use mode - for rear facing)
- 3 Harness Adjustment Strap
- 4 Harness Adjustment Latch
- 5 Car's seat belt
- 6 Blue Rear Facing Seat belt markers (1 each side) for rear facing mode
- 7 Upper Anchorage Storage Band
- 8 Upper Anchorage Strap Adjuster
- 9 Slots for adjusting height of shoulder straps
- 10 Shoulder Height Markers
- 11 Padded cover for baby's comfort (may vary in style)
- 12 Buckle Tongue Holders
- 13 Fully adjustable 6 point harness
- 14 Quick Release Buckle (Red button)
- 15 Adjustable Upper Anchorage Strap
- 16 Attachment Clip

## SUITABLE FOR USE

### BABY USE REARWARD FACING

TO BE USED WITH A LAP SASH OR LAP ONLY SEAT BELT IN THE BACK OF MOST CARS WITH FORWARD-FACING SEATS.

To be used only in a rearward-facing position for an infant until their shoulders reach the lower shoulder height marker (approximately 6 months of age).

Continue to use this restraint until the child reaches this limit.

Do not use forward facing until child's shoulders are above the lower shoulder height marker.

Infants are at risk of serious injury if they face forward too early. A baby's neck muscles may be unable to support their head thus the baby should remain in rear facing until the neck muscles become stronger.

The purchaser should check the measurements between the front of the seat back of the rear seat and all front seats in the car in which the child restraint is intended to be used, to ensure that the space is sufficient. If you have the restraint check it fits in your car.

Regional Road Rules may prohibit the use of this restraint in the front seat until the child is 4 years of age. Check your Regional Rules for exemptions.

### **WARNINGS**

**DO NOT USE RESTRAINT IN REARWARD FACING MODE WITHOUT STABILISING BAR FULLY EXTENDED.**

Do not use the restraint without the Upper Anchorage Strap correctly attached.

**DO NOT USE A REAR FACING CHILD RESTRAINT WHERE AN AIRBAG IS FITTED IN FRONT OF THE SEATING POSITION.**

Do not use on any vehicle seat which faces sideways or rearwards.

Never leave babies or toddlers in a stationary car in the sun because of the risk of heat exhaustion. Ensure babies and toddlers have adequate ventilation and are shaded from direct sunlight through side or rear windows.

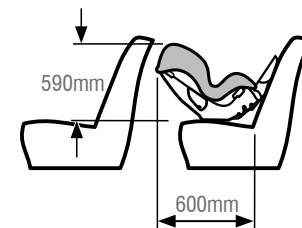

Do not allow the front seat to alter the installed position of the restraint. It is permissible to allow the restraint to touch the seat on front of it.

### ADJUSTING HARNESS STRAP HEIGHT: FOR BABY USE REARWARD-FACING

Correct fitment of the harness is very important as it restrains the baby in the restraint. The harness must fit firmly around upper torso of the baby and be positioned so as to leave the baby's arms and legs free.

For babies in rear facing mode, the infants shoulders must be below the lower shoulder height marker. If your baby has reached the lower shoulder height marker then the restraint must be converted for "Child Use". (Refer to Forward Facing section starting on page 26).

The shoulder straps must be in the slots which are nearest to the child's shoulders, but not lower than the child's shoulders when in rear facing mode.

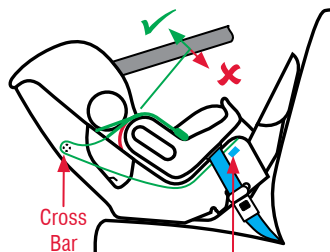
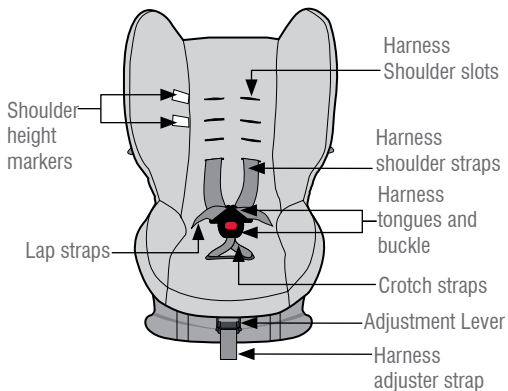

**REARWARD-FACING BELT PATH;**  
shown as blue.

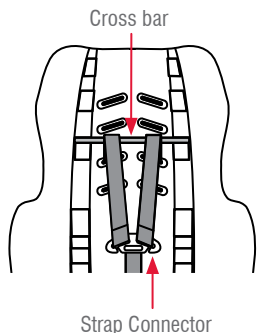

### **IMPORTANT:**

Shoulder straps **MUST** be threaded through appropriate shoulder strap slots then over the cross bar at the rear of restraint.

### CHANGING SHOULDER STRAP SLOTS: FOR BABY USE REARWARD-FACING

- A. If using the seat for the first time, you may need to use the second set of shoulder strap slots rather than the lowest pair of slots. Place baby in the seat and check which shoulder strap slots are best.
- B. If fitted in the car, remove the restraint from vehicle as instructed on page 25.
- C. To slacken Harness Straps, lift Harness Adjustment Lever then grasp both shoulder harness straps and pull outwards.

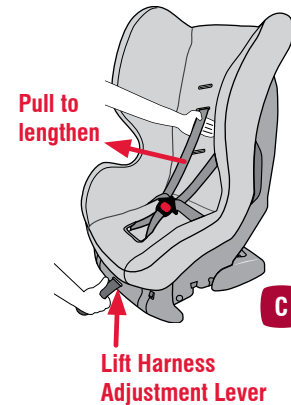

- D. At the rear of the restraint, remove one of the harness shoulder straps from metal Strap Connector by slipping strap through open slot. It is better to change one strap at a time.

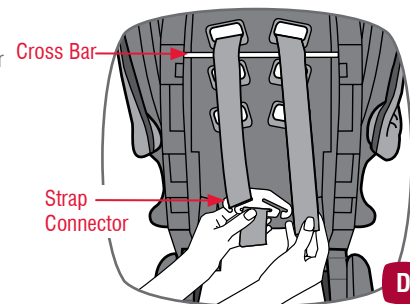

E. Pull the shoulder strap out of the slot.

F. Insert shoulder strap through the selected slot which will position shoulder strap level with or above the child's shoulder as shown right. Ensure that the Shoulder strap passes through matching slots in the cover and restraint body.

G. Ensure there are no twists in the shoulder strap and the buckle tongues face the correct way.

**CAUTION:** For Rearward facing, Ensure the shoulder strap is threaded through the slot, then **over the top of the cross bar** at the rear of restraint & connected to the metal strap connector.

H. Reconnect the strap to the metal connector.

I. Repeat for other shoulder strap. It is better to change one strap at a time so that the other strap will be a guide for re-assembly.

**CAUTION:** Do not use the restraint with harness shoulder straps set at different heights or fed through mismatching slots. Ensure harness straps are not twisted and that all straps are secure by pulling each harness strap.

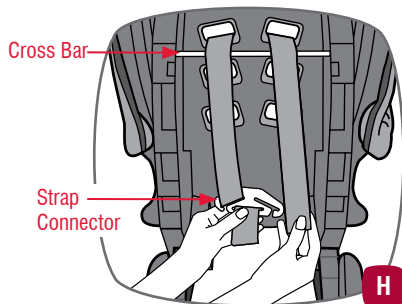
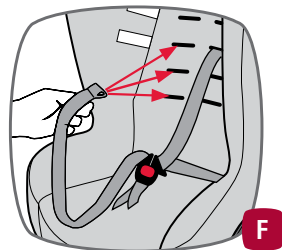
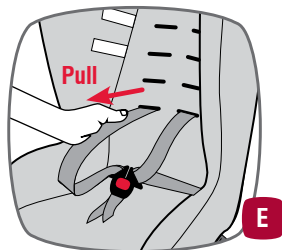

### CHILD RESTRAINT ANCHORAGE

To use this child restraint, the car will need a child restraint anchor fitting in the seating position that you intend to use. Refer to the car owner's handbook.

If no anchor fitting is provided then you will need to install an anchor fitting. Refer to pages 48 to 51.

The anchor fitting is required for attaching the upper anchorage strap in both rear facing mode and forward facing mode covered later in the these instructions.

### INSTALLING INTO VEHICLE (REARWARD FACING)

A. The car may be fitted with a child restraint anchor fitting behind the desired seating position. Refer to the car owner's handbook. If not then an anchor fitting will need to be installed. Refer to pages 48 to 51.

B. The restraint is normally packaged in the fully upright Child Use mode so you will need to convert it to Baby Use mode. Convert the restraint to Baby Use mode as shown & explained.

C. If Upper Anchorage Strap is folded up for storage undo from Storage Band then lengthen. Fully press Adjuster Button (1) while pulling Upper Anchorage Strap (2) to lengthen.

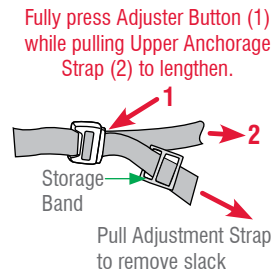



# HOW TO INSTALL

## BABY USE REARWARD FACING

D. To convert the restraint from forward facing mode to rearward facing mode for Baby Use, unlock the stabilising bar by pulling the bar backwards.

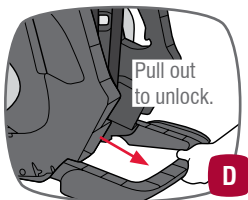

E. Rotate the stabilising bar around so that it is in position at the front of the restraint.

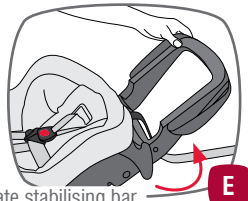

F. Push to lock the stabilising bar into position at the front of the restraint.

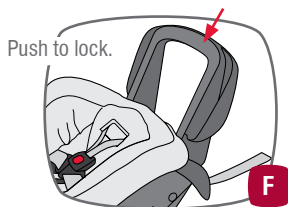

**! IMPORTANT:**  
DO NOT USE RESTRAINT IN REARWARD FACING MODE WITHOUT STABILISING BAR LOCKED IN POSITION

G. At the front of the seat unclip the plastic fasteners and pull back the trim to expose the seat belt slots in the restraint.

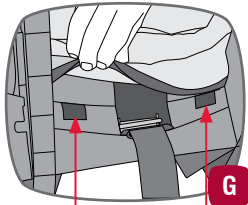

Unclip the plastic fasteners and pull back seat cover.

# HOW TO INSTALL

## BABY USE REARWARD FACING

H. Position the restraint in the car rearward facing in the chosen seating position.

Note: Some vehicle seat fabrics (particularly velours) may be damaged by a child restraint used continuously. We recommend the use of a messy mat or thick towel to keep the vehicle seat in good condition.

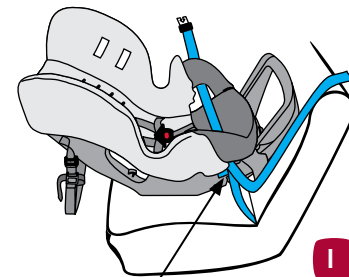

Blue marker to identify REARWARD FACING SEAT BELT PATH.

I. Feed the seat belt through the seat belt slots on each side of the restraint. The rear facing seat belt path is identified by the blue- REARWARD FACING SEAT BELT PATH marker (1 each side).

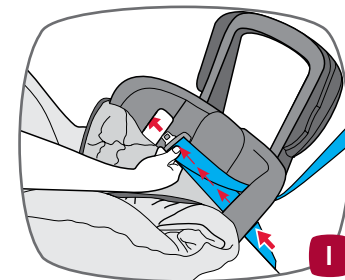

# HOW TO INSTALL

## BABY USE REARWARD FACING

J. Engage seat belt buckle and tongue.

K. Re-attach the cover by connecting the plastic fasteners and align restraint centrally to the chosen seating position.

L. Tighten the seatbelt. If installed with a lap-sash seat belt tighten both the lap and sash belts, then allow the sash-belt to feed into the retractor.

M. Hook the attachment clip to the car's anchor fitting. Remove as many twists as possible from the upper anchorage strap. (This may be done after the baby is fitted in to the seat).

**THIS TETHER STRAP MUST ALWAYS BE FITTED WHEN THE CHILD RESTRAINT IS USED IN A VEHICLE.**

N. Tighten adjustable upper anchorage strap by pulling adjustment strap (3) to remove slack, but do not over-tighten causing the restraint base to lift off the vehicle seat. This will usually be done once the baby has been harnessed into the seat.

**ALWAYS** roll up excess strap tightly and neatly store away from child's reach using the storage band.

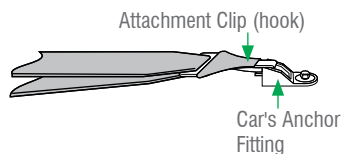
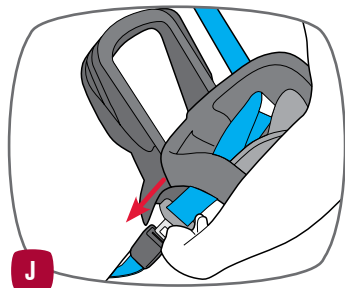

Fully press Adjuster Button (1) while pulling Upper Anchorage Strap (1) to lengthen.

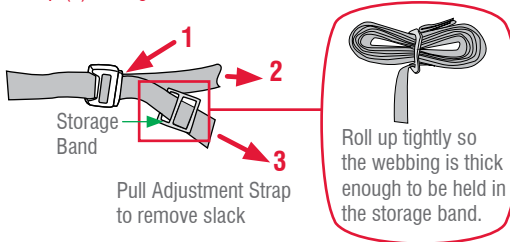

# HOW TO INSTALL

## BABY USE REARWARD FACING

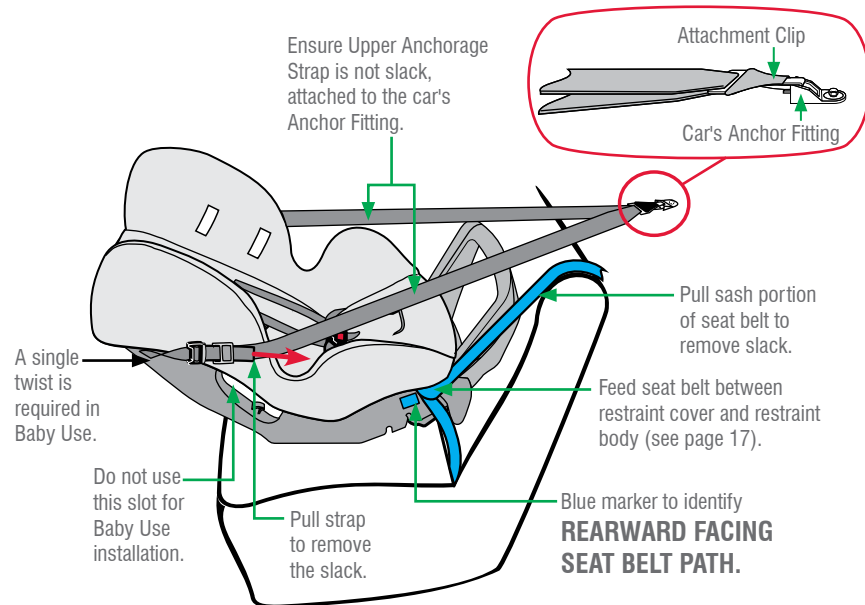

### **⚠ WARNINGS**

**DO NOT USE RESTRAINT IN REARWARD FACING MODE WITHOUT STABILISING BAR FULLY EXTENDED.**  
**THE UPPER ANCHORAGE STRAP MUST ALWAYS BE FITTED WHEN THE CHILD RESTRAINT IS USED IN A VEHICLE.**  
**ALWAYS ATTACH THE HOOK AND REMOVE THE SLACK.**



### IMPORTANT:

If using an Extension Strap, positioning the Attachment Clip above the baby may lead to injury in an accident therefore make sure that the Attachment Clip is not positioned in front of the vehicle seat.

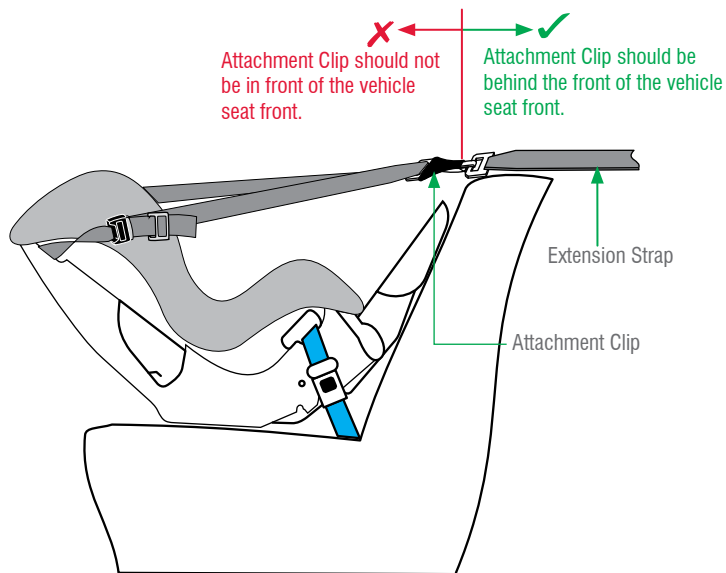

### ANGULAR ADJUSTMENT OF RESTRAINT

Some vehicle seats have more rearward slope than others. If the angle of the seat causes the baby to be too upright for comfort, the angle may be altered by placing a firm packing between the seat and the underside of the base. Packing can be a firmly rolled up towel or nappy.

Do not remove all of the rearward slope by over packing. Always leave a rearward slope angle of approximately 10 to 15 degrees as shown below.

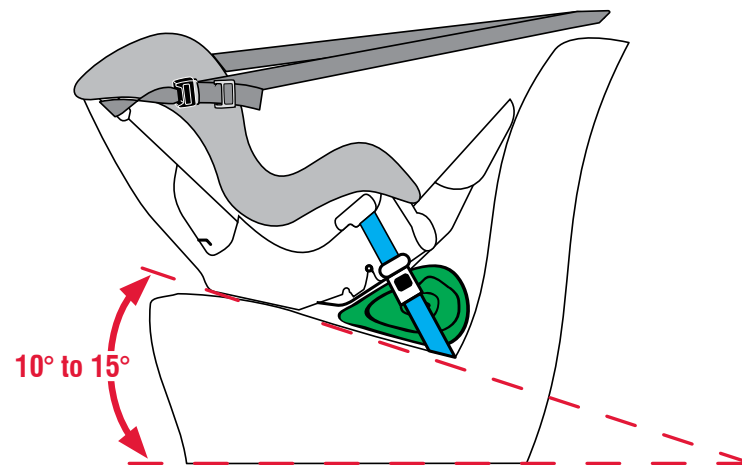

### PLACING BABY INTO RESTRAINT

A. Ensure the shoulder straps are adjusted to the correct height for your child (see page 12).

B. Slacken the Upper Anchorage Strap and allow the straps to fall to the sides of the restraint for easy access to the baby.

C. To slacken Harness Straps, lift Harness Adjustment Lever (1) then grasp both shoulder harness straps and pull out (2) till there is enough slack to place harness to each side of restraint. Store tongues on the Buckle tongue holders.

Buckle tongue holder on both sides of the seat. Push tongue inwards to engage.

D. Lay baby on their back into restraint and fit harness with the shoulder straps on the chest, and the waist strap at the child's hips. Pull the crotch strap and buckle between the legs.

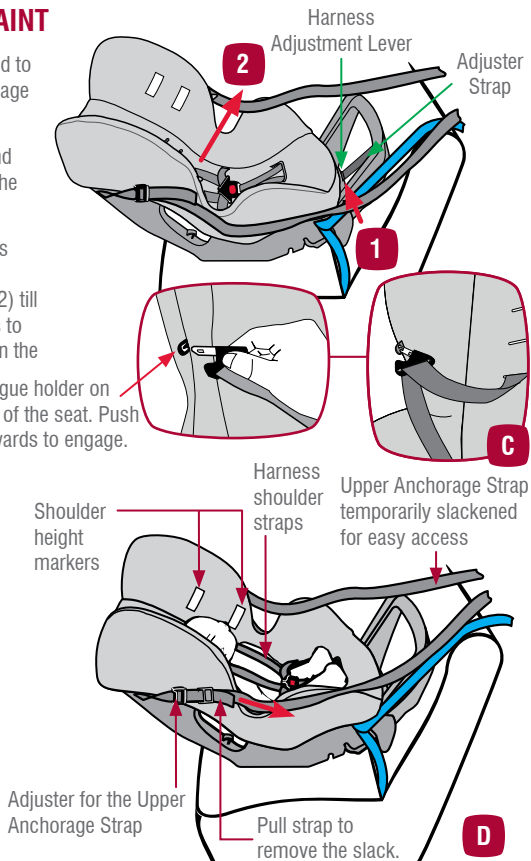

E. Always make sure the baby is dressed to allow harness buckle to be pulled up between baby's legs e.g. a jump suit. Make sure the baby's arms and legs are free.

**NOTE:** Never wrap baby in a blanket before placing in restraint. Place a blanket over the child after the harness has been tightened if additional warmth is required. Generally babies are warmer in the seat and may need to wear less clothes so they don't get too hot.

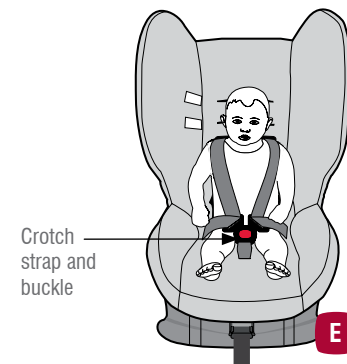

F. Fit either harness tongue into the harness buckle followed by the other tongue until a click is heard. Should the second tongue not insert, press the red button and reinsert the tongues. Ensure secure engagement by pulling harness straps.

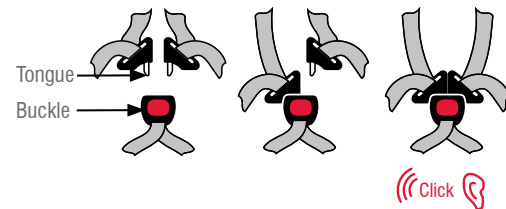

G. Remove slack from harness lap straps by pulling shoulder straps upwards.

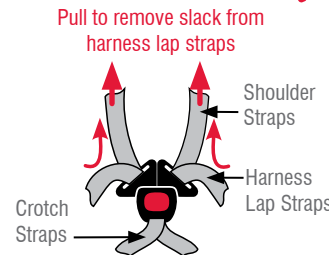

H. Pull harness adjustment strap to take up the slack in the harness adjusting to a comfortable but firm fit. A loose harness could result in serious injury in a crash.

### **CAUTION: A LOOSE HARNESS IS DANGEROUS.**

Make sure that nothing is obstructing harness straps and that baby's arms and legs are free with the straps in the correct location - as shown on the previous page. Do not use restraint if straps do not tighten and contact Customer Service for repair (telephone number at the back of this book).

**IMPORTANT:** A recommended Baby Insert Pad may be used to snugly support a baby. Do not use a baby insert pad that is not recommended for this child restraint by Babylove Products. Discontinue use when Baby Insert Pad is a tight fit or creates discomfort for larger babies or causes the baby's shoulder to reach the Lower Shoulder Height Marker.

I. Retighten Adjustable Upper Anchorage Strap by pulling Adjustment Strap (3) to remove slack as shown.

**ALWAYS** roll up excess strap tightly and neatly store away from child's reach using the storage band.

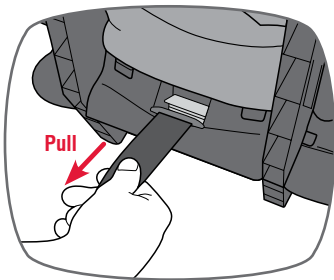
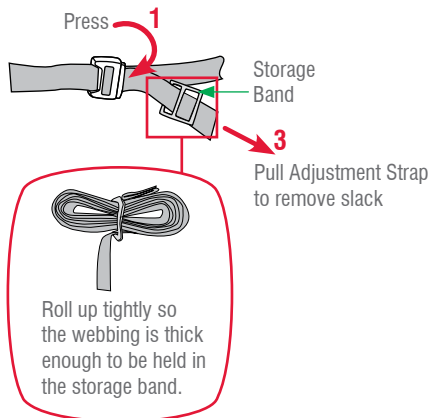

### REMOVING BABY FROM RESTRAINT

- Press Upper Anchorage Strap Adjuster Button (1) while pulling Upper Anchorage Straps (2) to slacken (as shown below). Allow Upper Anchorage Straps (2) to fall to the sides for easy access into restraint as shown right.
- Lift Harness Adjustment Lever, while pulling each Shoulder Harness Strap to slacken harness to the desired amount.
- Press red button on Harness Buckle then both Harness Tongues will be released. Move each shoulder strap to baby's side then pick up baby.
- Lift baby out of the seat.

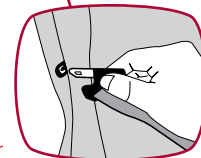
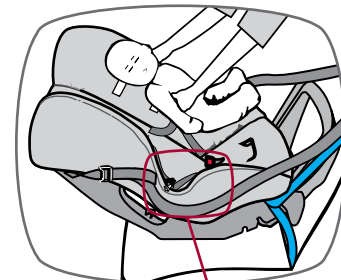

### TO REMOVE RESTRAINT FROM VEHICLE

- Disengage seat belt tongue from buckle and remove from restraint.
- Release the stored strap and fully press Upper Anchorage Strap Adjuster Button (1) while pulling Upper Anchorage Strap (2) to slacken as shown right.
- Disengage Attachment Clip from Anchor Fitting. The child restraint is now disconnected.

Fully press Adjuster Button (1) while pulling Upper Anchorage Strap (2) to lengthen.

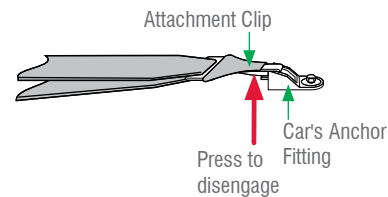
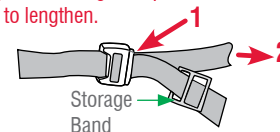

## SPECIAL FEATURES - Forward Facing

### TODDLER USE FORWARD FACING

To be used only in a forward-facing position by children whose shoulder's have reached the lower shoulder height marker (approximately 6 months of age) until the shoulders reach the upper shoulder height marker (approximately 4 years of age.)

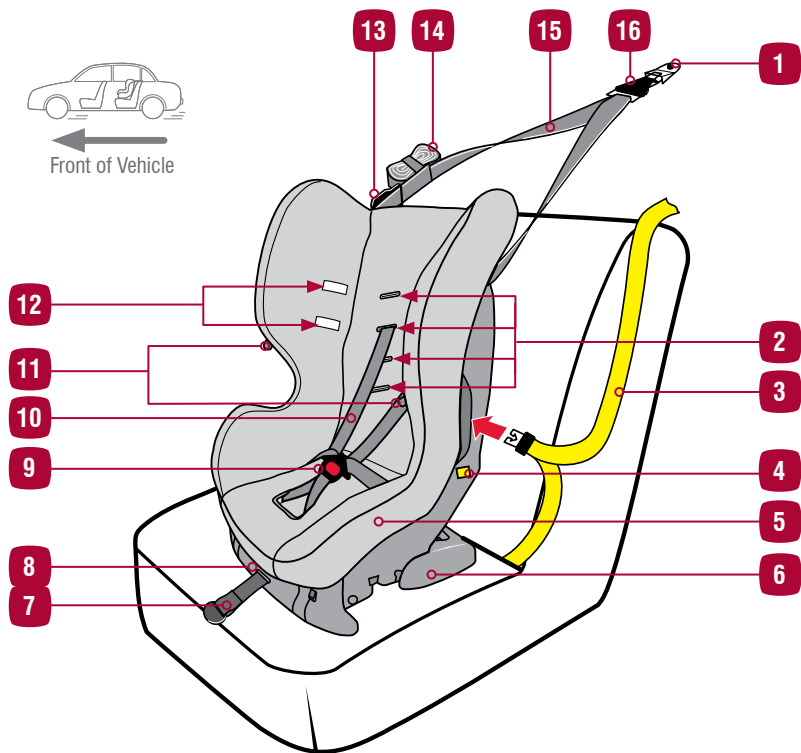

## SPECIAL FEATURES - Forward Facing

### TODDLER USE FORWARD FACING

- 1 Car's Anchor Fitting
- 2 Slots for adjusting height of shoulder straps.
- 3 Vehicle seat belt
- 4 Yellow Seat belt markers (1 each side) for forward facing
- 5 Padded Cover for comfort
- 6 Stabilising Bar (shown in Child Use mode)
- 7 Harness Adjustment Strap
- 8 Harness Adjustment Lever
- 9 Quick Release Harness Buckle (Red button)
- 10 Fully Adjustable 6 point harness
- 11 Buckle Tongue holders
- 12 Shoulder height markers
- 13 Upper Anchorage Strap Adjuster
- 14 Upper Anchorage Storage Band
- 15 Adjuster Upper Anchorage Strap
- 16 Attachment Clip

## TODDLER USE FORWARD FACING

TO BE USED WITH A LAP SASH OR LAP ONLY SEAT BELT IN THE BACK OF MOST CARS WITH FORWARD-FACING SEATS.

Once the child's shoulders reach the lower shoulder height marker then the seat can be changed to the forward-facing position and used until the child's shoulders reach the upper shoulder height marker (approximately 4 years of age).

Continue to use this restraint in this forward-facing mode until the child's shoulders reaches the limit of the upper shoulder height marker. The child should not sit forward-facing until the baby's neck muscles are able to support their head. Do not move to a Booster Seat until the child has outgrown this child restraint.

Regional Road Rules may prohibit the use of this restraint in the front seat of the vehicle until the child is 4 years of age. Check your Regional Rules for exemptions.

### WARNINGS

**DO NOT USE RESTRAINT IN FORWARD-FACING MODE WITH THE STABILISING BAR EXTENDED OUT THE FRONT OF THE RESTRAINT.**

Do not use the restraint without the Upper Anchorage Strap correctly attached.

If your vehicle is not fitted with an anchor point, please contact a Safety Restraint Fitting Station authorised by the relevant State Government Body for correct fitment of the restraint. In New Zealand contact the agent for the vehicle. The upper anchorage strap must be attached to an anchorage point using an extension strap if necessary.

Do not use on any vehicle seat which faces sideways or rearwards.

Do not use any Baby Inserts in Forward Facing 'Child Use' mode.

Do not use pillow unless recommended by Nursery Elegance Products Pty. Ltd.

If an airbag is fitted in the desired seating position where the child restraint is fitted, follow the vehicle manufacturer's warnings and instructions.

Children are at risk of serious injury if they move to a booster seat too early.

## TODDLER USE FORWARD FACING

### ADJUSTING HARNESS STRAP HEIGHT: FOR CHILD USE FORWARD-FACING

Correct fitment of the harness is very important as it restrains the child in the restraint. The harness must fit firmly around the upper torso of the child and be positioned so as to leave the child's arms and legs free.

The shoulder straps must be in the slots which are nearest to the child's shoulders, but not more than 25mm below the child's shoulders. If the child's shoulders are above the upper shoulder height marker then the child is too tall for the restraint and the restraint should not be used; move to next type of restraint (see page 8).

The shoulder straps must be in the slots which are nearest to the child's shoulders, but not more than 25mm below the child's shoulders.

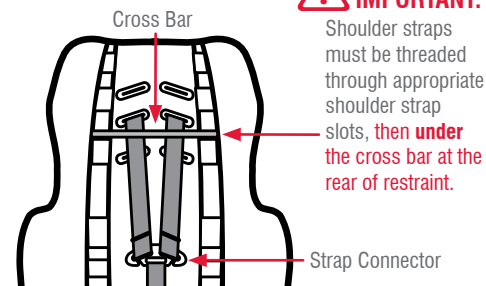
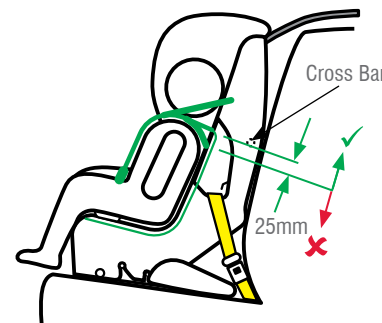
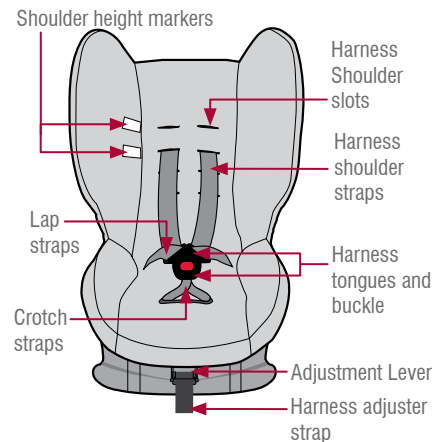

# HOW TO SET-UP

## TODDLER USE FORWARD FACING

### CHANGING SHOULDER STRAP SLOTS: FOR CHILD USE FORWARD-FACING

- A. Remove the restraint from vehicle as instructed on page 40.
- B. Slacken Harness Straps by lifting Harness Adjuster, grasping both shoulder harness straps and pulling out desired amount of slack.

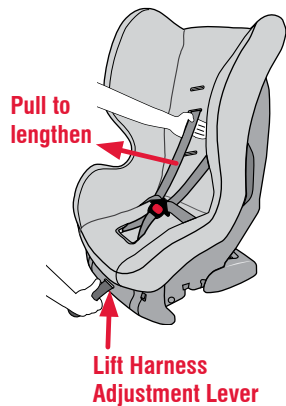

- C. At the rear of the restraint, remove one of the harness shoulder straps from metal Strap Connector by slipping strap through open slot.

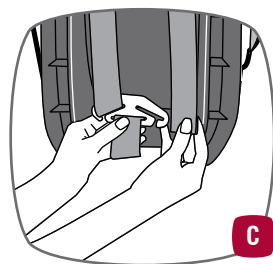

# HOW TO SET-UP

## TODDLER USE FORWARD FACING

- D. Pull the shoulder strap out of the slot.

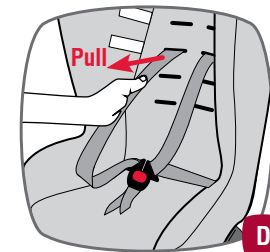

- E. Insert shoulder strap through restraint slot which will position shoulder strap level with or above the child's shoulder as shown right. Ensure that the Shoulder strap passes through matching slots in cover and restraint body.

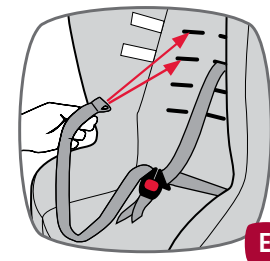



# HOW TO SET-UP

## TODDLER USE FORWARD FACING

F. Ensure there are no twists in the shoulder strap and the buckle tongues face the correct way.

**CAUTION:** For Forward facing, ensure the shoulder strap is threaded through the slot, then **under** the bar at the rear of the restraint & connected to the metal strap connector.

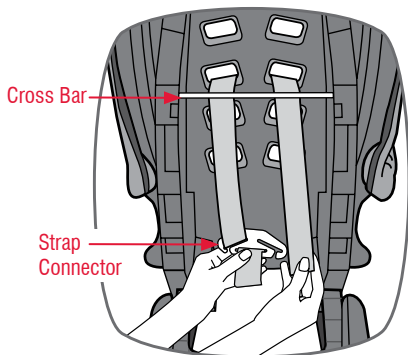

G. Reconnect the strap to the metal strap connector.

H. Repeat for other shoulder strap. It is better to change one strap at a time so that the other strap will be a guide for re-assembly.

**CAUTION:** Do not use the restraint with harness shoulder straps set at different heights or fed through mismatching slots. Ensure harness straps are not twisted and that all straps are secure by pulling each harness strap.

**IMPORTANT:** Ensure harness is correctly adjusted with the harness in the slots near the child's shoulders before refitting the seat to the car. (Refer to page 29)

# HOW TO INSTALL

## TODDLER USE FORWARD FACING

### INSTALLING INTO VEHICLE (FORWARD FACING) (UPRIGHT OR RECLINED)

A. Remove the rear facing seat from the vehicle by disengaging the seat belt and upper anchorage strap refer to page 25. If not previously fitted rearward facing, you will need to locate a child restraint anchor fitting. The car may be fitted with a child restraint anchor fitting behind the desired seating position. Refer to the car owner's handbook. If not, then an anchor fitting will need to be installed. Refer to pages 48 to 51.

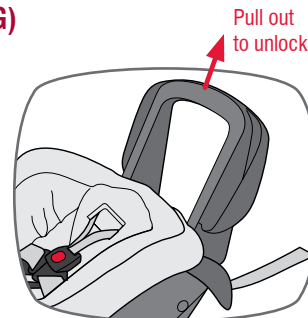

### CONVERT TO TODDLER USE MODE

Convert the restraint from Baby Use mode to Toddler Use mode as shown & explained below.

B. Remove the baby insert pad as this is no longer required.

C. To convert the restraint from rearward facing mode to forward facing mode for Toddler Use, unlock the stabilising bar.

D. Swing the stabilising bar around so that it is in position at the bottom rear of the seat.

E. Determine whether an upright or reclined position is preferred (see below) and adjust as described on the following page.

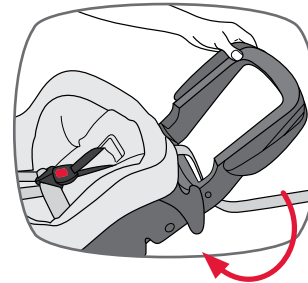

**IMPORTANT:** Do not use forward-facing with the stabilising bar extended. Always store away.

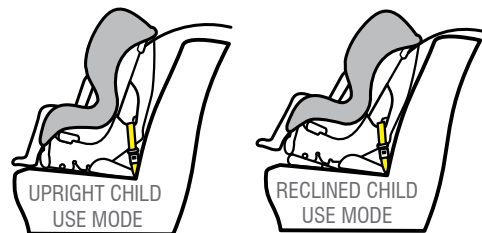

# HOW TO INSTALL

## TODDLER USE FORWARD FACING

F. Push to lock the stabilising bar into **upright** forward facing position. Refer to illustration for location of **Upright Slot**.

### UPRIGHT MODE

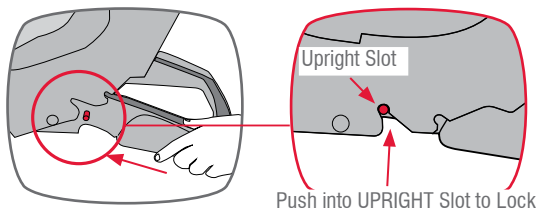

### OR RECLINED MODE

Push to lock the stabilising bar into **reclined** forward facing position. Refer to illustration for location of **Recline Slot**.

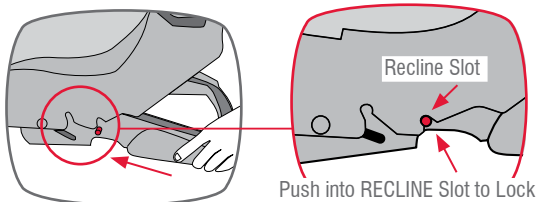

**WARNING**

**DO NOT USE RESTRAINT IN FORWARD-FACING POSITION WITH THE STABILISING BAR EXTENDED OUT THE FRONT OF THE RESTRAINT.**

# HOW TO INSTALL

## TODDLER USE FORWARD FACING

G. Position restraint in forward facing mode and align restraint centrally to the chosen seating position.

Some vehicle seat fabrics (particularly velours) may be damaged by a child restraint used continuously. We recommend the use of a messy mat or thick towel to keep the vehicle seat in good condition.

H. Fully lengthen seat belt. Insert seat belt into Child Use seat belt path (identified by yellow marker), ensuring that the seat belt is not routed between the harness and the back of the restraint, and that the lap part of the seat belt is below the hooks.

I. Engage seat belt buckle and tongue, ensure to remove all slack from lap part of seat belt by pulling sash belt. Adjust the seat belt to hold the restraint firmly against the vehicle seat. For inertia/retractable seat belts, allow excess belt to feed back into retractor.

NOTE: Seat belt extenders should not be used if the seat belt is not long enough to secure the child restraint. If they are used then the buckle tongue must not enter the seating zone.

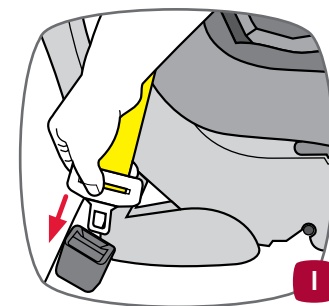
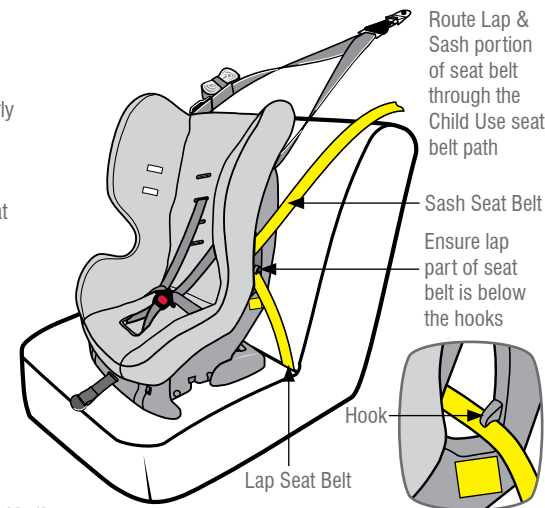

J. Hook the attachment clip to the car's anchor fitting as shown. Make sure to remove as many twists as possible from the upper anchorage strap..



### WARNING

Always attach the hook and remove slack

K. Tighten Adjustable Upper Anchorage Strap by pulling adjustment strap to remove slack as shown, but do not over-tighten causing the restraint base to lift off the vehicle seat.

L. **ALWAYS** roll up excess strap tightly and store behind the seat away from child's reach using the storage band.

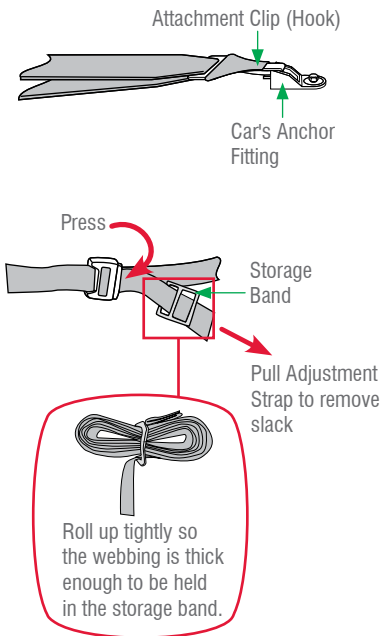

**IMPORTANT:** Always roll up the excess Upper Anchorage Strap and store behind the seat, otherwise it may hang outside of the car door or could strangle a child.

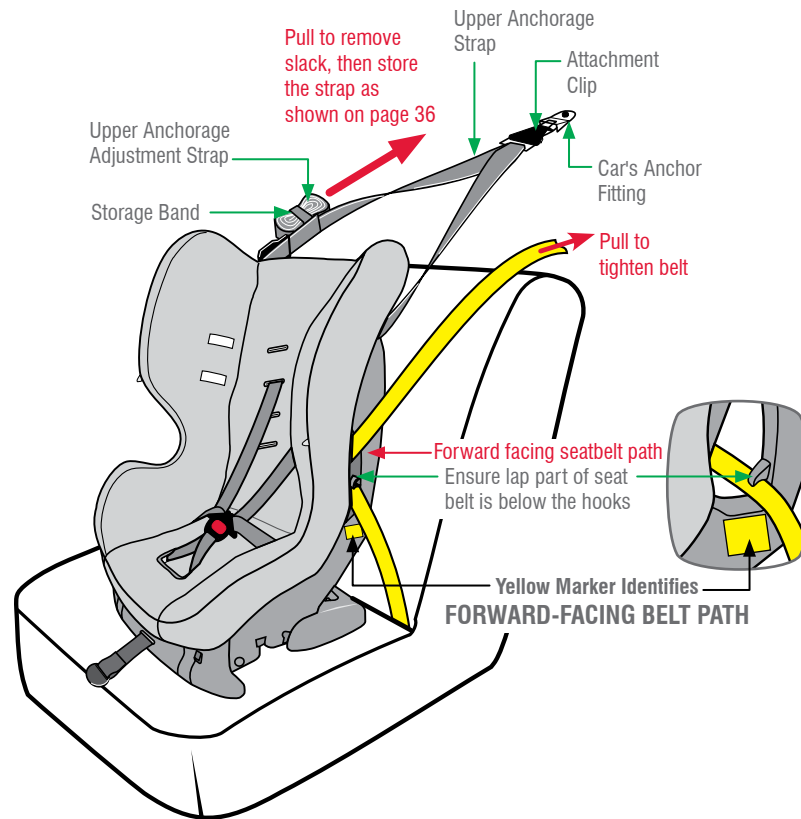

### PLACING TODDLER IN THE RESTRAINT

A. Lengthen harness by lifting up Harness Adjuster Lever while pulling on either shoulder strap until the harness will accommodate the child. Store the tongues on to the Buckle tongue holder on both sides of the seat.

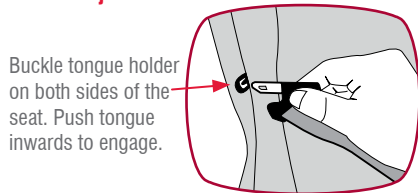
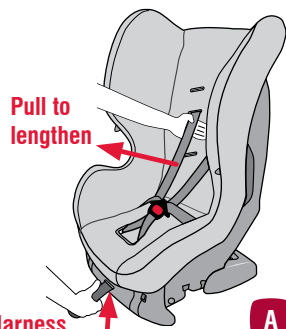

B. Place child in the restraint and feed each arm through shoulder straps. Pull harness buckle up between child's legs.



C. Fit either harness tongue into the harness buckle followed by the other tongue until a click is heard. Should the second tongue not insert press the red button and reinsert the tongues. Ensure secure engagement by pulling harness straps.

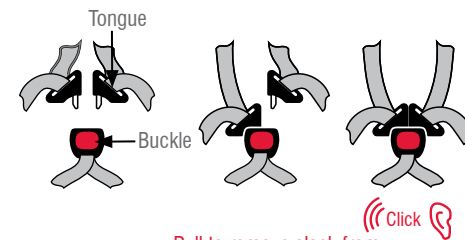

D. Ensure all slack is removed from harness lap straps by pulling shoulder straps the pull harness adjustment strap to adjust harness to a comfortable but firm fit. Check that the slack in straps is removed. Shoulder Harness Straps must fit firmly to the child. A loose harness could result in serious injury in a crash.

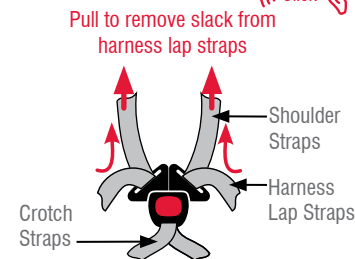

**CAUTION: A LOOSE HARNESS IS DANGEROUS.**  
Do not use restraint if straps do not tighten and contact Customer Service for repair (telephone number at the back of this book).

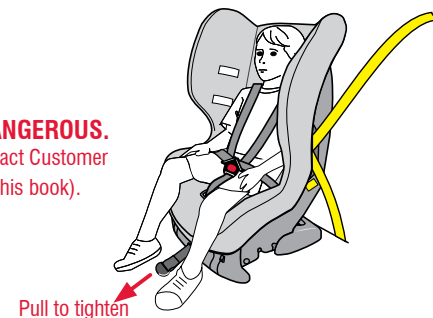

## TODDLER USE FORWARD FACING

### REMOVING CHILD FROM RESTRAINT

- Press red button on Harness Buckle then both Harness Tongues will be released. Lift the shoulder straps from the child's shoulders and remove the child from the car. The seat is ready for use next time although harness adjustments will be needed from time to time.

### TO REMOVE RESTRAINT FROM VEHICLE

- Disengage seat belt tongue from buckle and remove from restraint.
- Release the stored strap and fully press Upper Anchorage Strap Adjuster Button (1) while pulling Upper Anchorage Strap (2) to slacken as shown right. In some vehicles loosening of the Upper Anchorage Strap may be difficult. If so, try pushing the restraint against the vehicle seat back or slightly lifting the restraint to release the tension.
- Disengage Attachment Clip from Anchor Fitting. The child restraint is now disconnected.

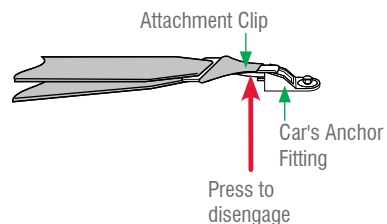
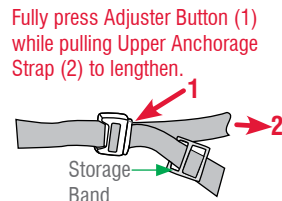

### REGULAR CARE OF THIS RESTRAINT:

Please check the following items regularly to ensure the safety of your child:

- Check the webbing for fraying.
- Check that the buckle clicks and is not sluggish or sticky in operation.
- Ensure there are no cracks in moulding or the plastic moulding.
- Check the harness adjuster is operating and is clamping the webbing.
- If any part of the restraint is cracked or broken, seek repair immediately or replace the child restraint.

### TO CLEAN HARNESS BUCKLE:

If sticky liquids such as baby formula, fruit juice, etc. get inside your Harness Buckle, it may become sluggish. An indication of a sluggish Harness Buckle is that you cannot hear a click when engaging the Harness Tongues. To restore the Harness Buckle to good working order it needs to be cleaned as follows:

- From the underside of the restraint pull each crotch 3-bar slide then turn 3-bar slide and push through each slot to remove the Harness Buckle from the restraint.
- Place the Harness Buckle under warm (max. 40 degrees Celsius) running water as shown. Let the water run through the mouth of the buckle for five minutes.
- Engage and disengage the Harness Tongues and Buckles several times until a strong audible click is heard.
- If you still cannot hear a strong audible click after engaging the Harness Tongues & Buckle, then repeat cleaning several times. If the Harness Buckle cannot be returned to its original working condition then contact Nursery Elegance.
- Refit the harness buckle to the restraint with the red button facing out & feeding each 3-bar slide through appropriate slot.

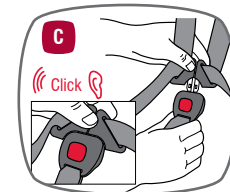
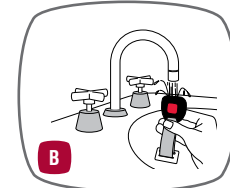
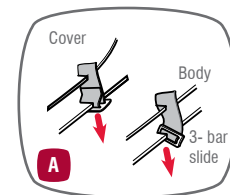

## CLEANING THE SEAT

Use only mild soap and water to clean all metal and plastic parts of the restraint. Do not use chemicals or cleaning agents.

## HOW TO CLEAN THE COVER

The restraint has a flame retardant cover which is removable for cleaning. Cleaning instructions are on the care label attached to the cover. When washing cover engage any hook & loop strips together to eliminate other garments being caught.

The cover has been designed to protect your child when seated in the restraint. Care should be taken if children either eat or drink while in the restraint as some food or drink products may cause damage or marking to the cover.

Do not pull sticky items from covers as the cover may be damaged - soak in water and gently remove.



### VERY IMPORTANT:

Only use this child restraint with the cover supplied or a manufacturer-  
authorised replacement cover with identical shoulder height markers.

## TO REMOVE COVER

You do not have to remove the harness assembly from the restraint. However, you do need to disconnect the shoulder harness straps from the metal strap connector at the back of the restraint (refer to page 30). Then follow the sequence A to G on the following page to remove the cover.



**IMPORTANT:** ONLY USE SEAT COVERS AND ACCESSORIES THAT ARE DESIGNED AND TESTED FOR USE WITH THIS PRODUCT AND RECOMMENDED BY NURSERY ELEGANCE PTY LTD.

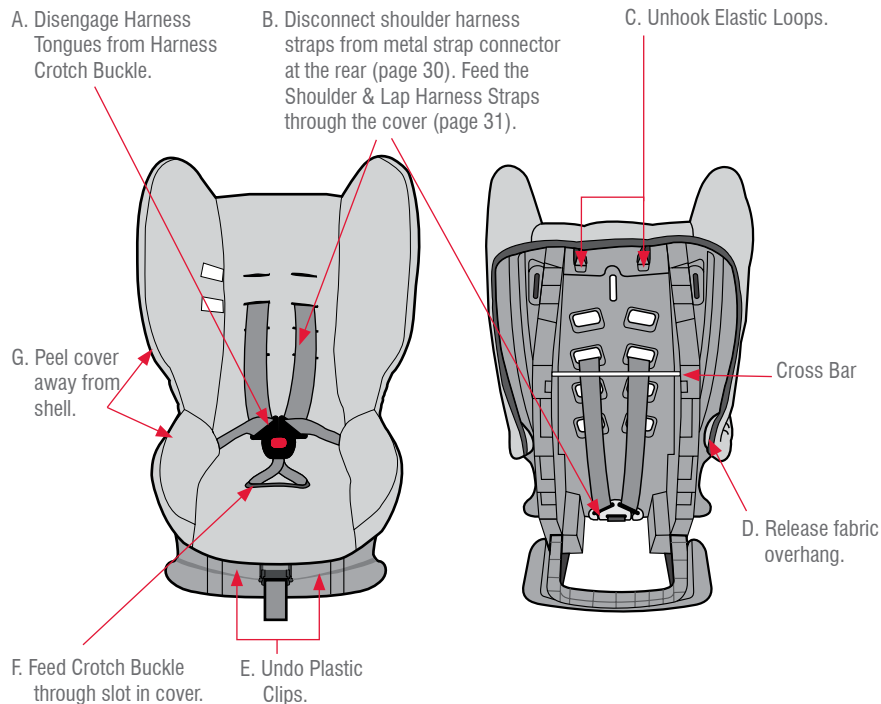

## TO REFIT COVER

To replace cover refit in reverse sequence G to A. Remember which shoulder strap slots that you took the shoulder straps from. Refer to pages 13 to 15 (Rearward facing) or page 30 to 32 (Forward Facing) for full details of refitting the shoulder straps. Ensure that the harness strap passes **over** the cross bar for rearward facing or **under** the cross bar for forward facing.

The following instructions apply to accessories that may be supplied with this restraint at point of purchase. If not, a variety of accessories are available from various retailers of Nursery Elegance. In the case of a small baby, accessories are available to improve the installed position of the baby in the restraint.

### HEAD PILLOW (If supplied)

The Head Pillow is designed to provide extra comfort and head positioning and is suitable in Rearward facing only. Fitting may be by way of slots in the Head Pillow, These need to be used to ensure it stays in position. See page 14 for strap connection instructions.

### SHOULDER PADS (If supplied)

Shoulder Pads may be provided for extra comfort for baby or child and are easily fitted to the shoulder harness straps by:

- A. At the rear of restraint remove the left hand harness shoulder strap from metal strap connector by slipping the strap through the open slot.
- B. Pull the shoulder strap through the shoulder strap slot in the restraint and cover, then feed through shoulder pad.
- C. Refit the shoulder strap through the shoulder strap slot in the restraint and cover then re-attach to metal strap connector. Ensure the path of the strap matches the right hand harness shoulder strap. Repeat these steps to fit shoulder pad to the right hand harness shoulder strap.
- D. Alternatively the shoulder pads may have press studs for attachment.

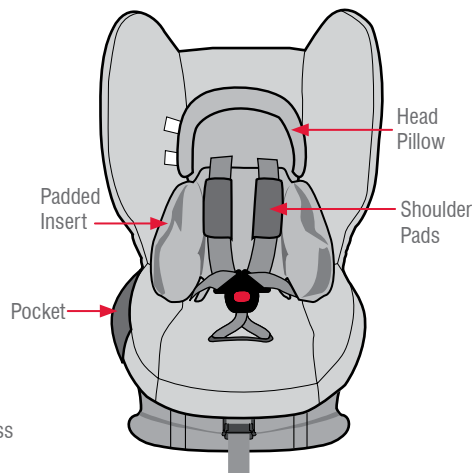

### PADDED INSERT (If supplied)

The Baby Insert Pad is designed to snugly support the baby for extra comfort. Fit padded insert between Harness straps and restraint as shown, ensuring insert is lined up or below shoulder straps.

Do not use the Padded Insert in forward facing mode (Toddler Use).

### POCKETS (if fitted to the cover)

The pockets sewn on the trim are designed for your convenience. They can hold those necessary items that you need at a moments notice. e.g Bottle, face washer, toy etc.

**CAUTION:** If using the pocket to store filled bottles, please ensure contents are not contaminated due to prolonged storage.

## CUP HOLDER (If supplied)

The cup holder can be fitted onto both sides of the seat.

- Raise the cover and locate fixing slots in shell.
- Clip cup holder into position, then re-fit cover. Ensure the cup holder and its contents cannot be crushed by the car door. Remove or reposition the cup holder to the opposite side as required.

**NOTE:** Only use for holding cups and bottles.

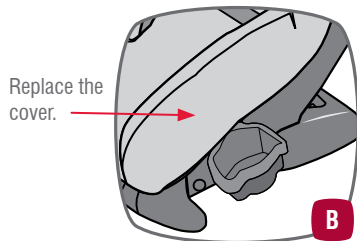
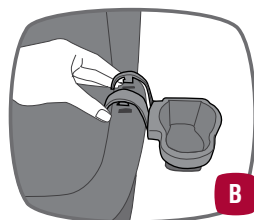
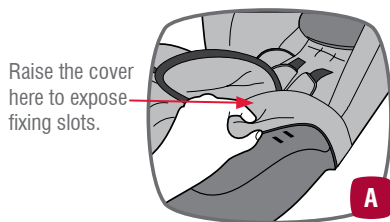

## MESSY MAT™ SEAT PROTECTOR (If supplied)

Place ribbed or pocket end of the Messy Mat™ seat protector on edge of car seat, smooth back toward seat join ('A') and fit in any excess Messy Mat™ into the join of the car seat ('A').

### Short Messy Mat™

### Long Messy Mat™

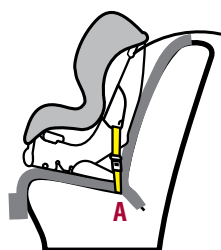
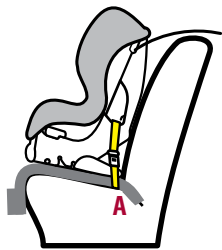

### CAUTION:

The pocket is only for small, light items. DO NOT overload the pocket with heavy, bulky items as this may damage the pocket or cause passengers to trip over them

## SAFETY

Never hold a baby in arms when riding in a motor vehicle. In this position the baby could be thrown against the dashboard, windscreen or other occupant and suffer serious injury or death.

When riding in a motor vehicle never nurse a baby and use the same seat belt for both of you. In this position the baby or child could be crushed.

Children must be secured in appropriate restraints at all times when the car is in motion. Children travelling unrestrained and standing up in the car are in danger of serious injury or death. Traffic regulations in all states require children to be secured in child restraints or adult seat belts where available.

Plan your trip with frequent comfort stops to reduce stress on babies, young children and driver. Keep the car well ventilated to reduce heat stress. Two car windows should be kept open to maintain a good flow of fresh air if air conditioning is not used.

Never leave babies or toddlers in a stationary car in the sun because of the risk of heat exhaustion.

Ensure babies and toddlers are adequately shaded from direct sunlight through side or rear windows.

Be on guard against carbon monoxide poisoning which can occur through only a slight leak in the exhaust system while travelling in a closed car.

Securely stow all heavy objects, feeding bottles, etc. that could become missiles during an accident and cause injury to any occupant.

## CLOTHING/BATHING

Take several changes of clothing and bibs for possible car sickness. Disposable nappies and liners are very handy while travelling. Since it is often warmer in the car, dress the baby in light clothing. When cooler, it is easier to place a blanket over the baby than it is to remove the baby from the restraint and change clothes.

## FEEDING

Never breast feed a baby while car is in motion. Babies will require extra feeding if travelling in the heat. For bottle fed babies, make up the bottles and refrigerate before leaving home for a day trip. Place in a cool bag and reheat as needed with hot water from a thermos.

Alternatively, bring boiled water in a thermos and pre-measured amounts of baby formula in small containers. Use the water from the thermos to mix with the formula when required. Regardless which method is used, it is always a good plan to carry some boiled water in a sterile container or bottle.

Do not attempt to carry warm milk because germs multiply rapidly in warm milk.



## PRE-INSTALLATION ANCHOR FITTING

Consult the vehicle owner's handbook for location of anchorage fittings or anchorage points and the possible use of spacers. Some vehicles may have an anchor fitting fitted by the vehicle manufacturer. If anchorage points cannot be found refer to car manufacturer or local child restraint fitting station or traffic authority for optimum position of anchorage point and the use of spacers.

### UPPER ANCHORAGE STRAP



#### IMPORTANT:

THE ATTACHMENT CLIP COVER MUST ALWAYS BE USED AS IT PREVENTS THE RISK OF INCORRECT FITMENT OF THE ATTACHMENT CLIP TO THE ANCHOR FITTING. ALWAYS ENSURE THAT THE ATTACHMENT CLIP IS CORRECTLY ENGAGED TO THE ANCHOR FITTING AND NOT HOOKED OR FITTED TO ANY OTHER OBJECT BEFORE EACH USE OF THE RESTRAINT. THIS IS ESPECIALLY IMPORTANT IN VEHICLES SUCH AS STATION WAGONS, VANS, HATCH BACKS OR VEHICLES WITHOUT A FIXED PARCEL SHELF, SINCE THE ANCHOR POINT IS USUALLY NOT VISIBLE.

#### IMPORTANT INSTALLATION NOTE:

In some vehicles the anchor fitting in the rear vertical panel can only be installed in one way. Please refer to vehicle owner's handbook or a child restraint fitting station for correct method.

## PRE-INSTALLATION ANCHOR FITTING

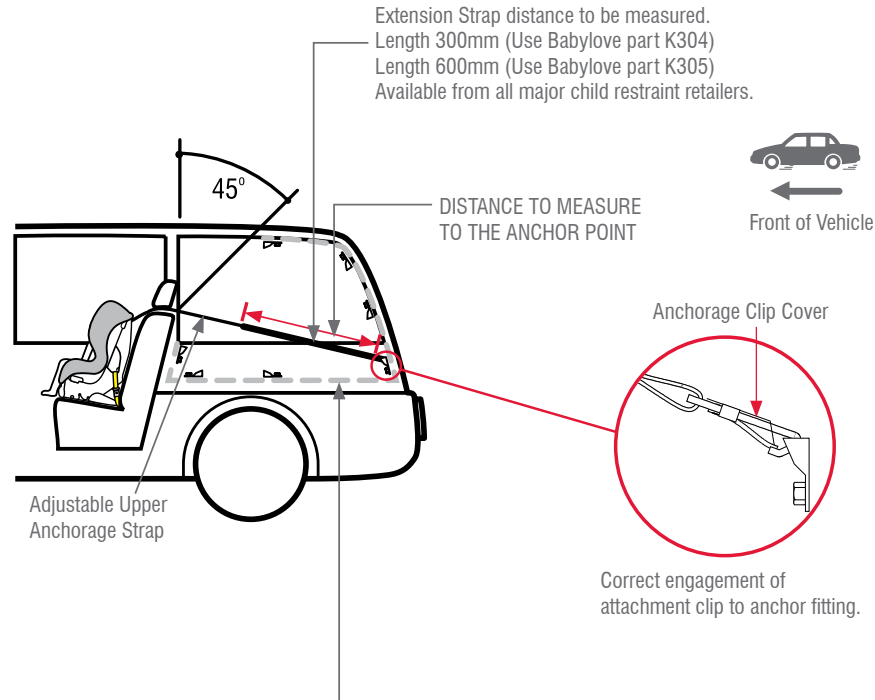

The shaded areas of this diagram illustrate the possible locations of the anchor fitting. Within each shaded area is an anchor fitting showing the correct way to install the fitting. Ensure the anchor fitting is aligned as illustrated unless stated otherwise in the vehicle owner's handbook.

## PRE-INSTALLATION ANCHOR FITTING

### IF THE CAR IS FITTED WITH CHILD RESTRAINT ANCHORAGE POINT

Locate the anchorage point behind the rear seating position. (consult the car owners handbook for the location of the anchorage point). The anchorage point should be directly behind and central to the restraint. Remove thread plug from the parcel shelf/floor/roof, etc. and install anchor bolt and fitting as shown in Fig.1.

**CAUTION: DO NOT OVERTIGHTEN ANCHOR BOLT. OVERTIGHTENING MAY FRACTURE OR BREAK BOLT. MAXIMUM TORQUE IS 20 N.M. (14.75 ft.lb.)**

Note: Minimum of five full turns of anchor bolt is required before tightening force is applied.

### IF THE CAR IS NOT FITTED WITH CHILD RESTRAINT ANCHORAGE POINTS

**For Sedans only** - Drill 9mm diameter hole in the parcel shelf on the centre line of the seating position as shown in Fig.3. Before drilling the hole, check the underside for accessibility. Install the anchor bolt as shown in Fig.2.

**For vehicles other than Sedans** - In Australia, consult your nearest child restraint fitting station or traffic authority for vehicle inspection to find the best, correct position for the placement of the anchorage point, and for the correct attachment bolt length and use of spacers. In New Zealand, consult the agent for the vehicle.

Note to Queensland purchasers: The installation of anchorage points must be approved by authorised officers appointed by Queensland Transport. Authorised officers can be sourced from all Queensland Transport Customer Service and Queensland Ambulance Service Centres.

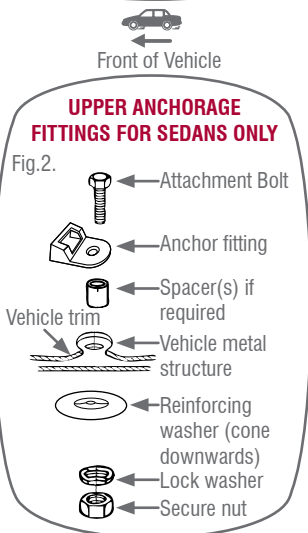
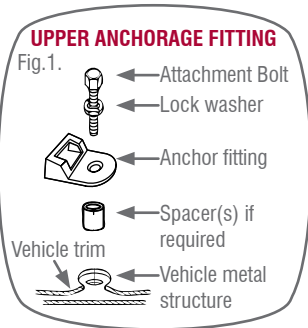

ONLY USE A 5/16 UNC GRADE 5 BOLT. IF THE BOLT IS NOT THE CORRECT LENGTH THE CAR MANUFACTURER'S HANDBOOK CAN PROVIDE ADVICE ON THE CORRECT LENGTH BOLT.



**CHILD RESTRAINTS MUST NOT BE ATTACHED TO UNSOUND METAL OR TO WOOD, OR SYNTHETIC STRUCTURES. WHEN DRILLING 9 MM HOLE DO NOT DRILL THROUGH FUEL LINES, FUEL TANKS, ELECTRICAL WIRING, OR RADIO SPEAKERS.**

**WEBBING STRAPS MUST BE PROTECTED FROM SHARP CORNERS AND EDGES. THE ANCHOR FITTING MUST BE USED ONLY AS DESCRIBED ABOVE. IT MUST NOT BE HOOKED ONTO ANY OTHER OBJECT.**

### VEHICLE INSTALLATION ACCESSORIES

(Available from retailers of Babylove products)

**EXTRA ANCHOR KITS:** Are available if using the restraint in additional vehicles.

Re-order number: K402

**EXTENSION STRAPS:** May be required for vehicles without a fixed parcel shelf.

Re-order number: K304 (length 300mm)  
or K305 (length 600mm).

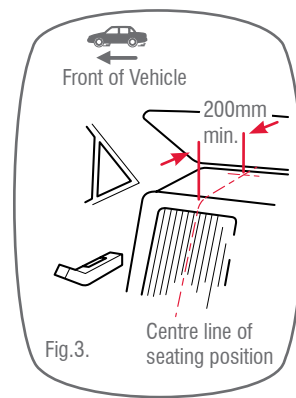

If your restraint has been involved in a severe crash, you should destroy the restraint even if no damage is obvious. Some insurance companies offer vehicle insurance which covers or partially covers the replacement of your child restraint. Contact your insurance company for further details.

Your insurance company may require you to keep the child restraint for assessment, **but do not use the child restraint after a severe crash.**



## **AUSTRALIA**

Nursery Elegance Pty Ltd

A.B.N 84 122 443 387

Unit 10, 339 Williamstown Rd.

Port Melbourne, Victoria 3207.

Phone number: 1300 131 477

## **NEW ZEALAND**

Phone number: 0508 688 822

**[www.nurseryelegance.com.au](http://www.nurseryelegance.com.au)**

**[info@nurseryelegance.com.au](mailto:info@nurseryelegance.com.au)**

We reserve the right to alter this product without notice in our constant endeavor for improvement.

©2007-2011 Nursery Elegance Pty. Ltd.

Babylove, EzySwitch Trademarks are the property of Nursery Elegance Pty Ltd.

This product is covered by Australian and Overseas patents and applications.

Patents Pending.

**P/No. 2200617/A**

