



**IMPORTANT: KEEP THIS BOOKLET IN THE
PLACE PROVIDED ON THE CHILD RESTRAINT**

INFANT CARRIER

INSTRUCTION BOOK

Series No. BL620A/2013

baby 
loveTM

QUICK SETUP WITH SEATBELT

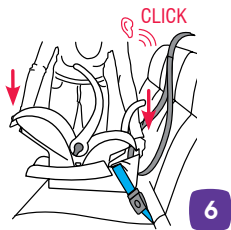
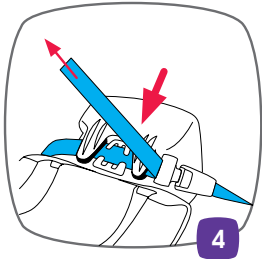
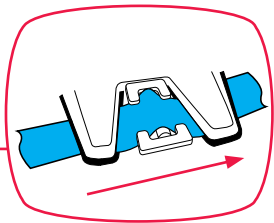
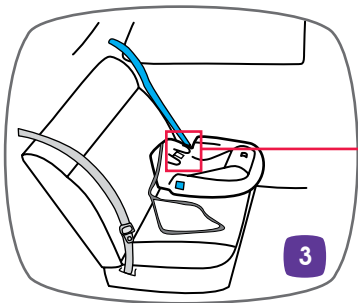
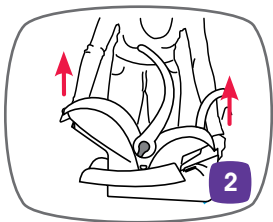
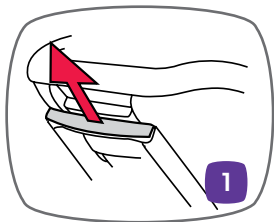

QUICK SETUP WITH SEATBELT

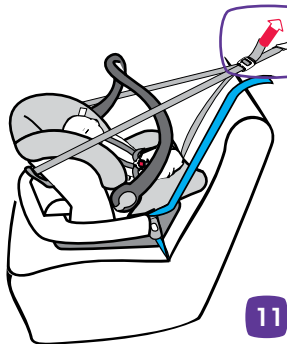
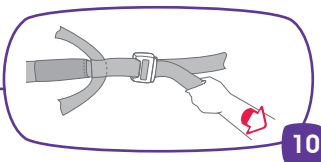
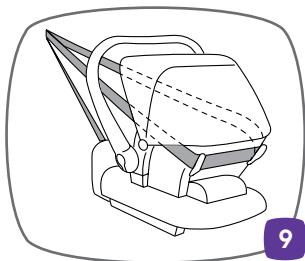
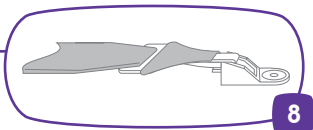
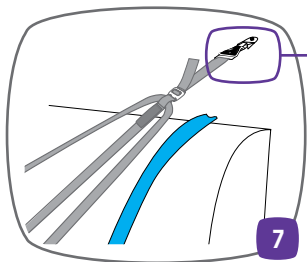



INTRODUCTION

To be used only in a rearward-facing position until the infant's shoulders reach the shoulder height marker (approximately 6 months of age).

Continue to use this infant restraint until the child reaches this limit.

Infants are at risk of serious injury if they face forward too early.

متم الة إلى عي ضرر الة يف تك لصي ى تح فلخل الة إلى لة ج اوم الة عي ع ضول الة يف طقف اءم ادخت سا م تي
(رهشأ لة تس رمع يف أب يرق ت) فاتك أ الة عا فت را

دحل الة اذة إلى ل ل فطل ال لوصو نل ج ل اذة ع ضرل الة ج اءم ادخت سا م يف رم ت سا

ءرك بم ءروص ب م الم الة إلى م هه جوت م اذ ل ءرل طخل الة اب اص الة إلى لة ل ءر ط اءم يف ع ضرل الة نو ك ي
م زال الة ن م ر ثك أ

Chỉ được sử dụng ở vị trí hướng mặt về phía sau cho đến khi vai em bé cao lên tới vạch ghi độ cao của vai (khoảng 6 tháng tuổi).

Hãy tiếp tục sử dụng ghế em bé này cho đến khi em đạt tới giới hạn này.

Bé sơ sinh có nguy cơ bị chấn thương nghiêm trọng nếu chúng hướng mặt về phía trước quá sớm.

Sólo deben utilizarse orientadas hacia atrás hasta que los hombros del niño alcancen el marcador de altura (aproximadamente a los 6 meses de edad).

Utilice este sistema de seguridad infantil hasta que el niño alcance ese límite.

El niño corre el riesgo de sufrir lesiones graves si se utiliza la silla orientada hacia adelante antes de tiempo.

僅可後向安裝使用，直至嬰兒肩膀達到肩膀高度標記（大約6個月大）。

孩子應一直採用後向式坐姿，直至其達到後向式坐姿的上限。

孩子若過早乘坐前向式汽車座椅，可能會對其造成嚴重的傷害。



INTRODUCTION

Magagamit lamang sa isang nakaharap sa likuran na posisyon hanggang sa maabot ng balikat ng sanggol ang marka ng taas ng balikat (humigit-kumulang 6 na buwang edad). Ipagpatuloy ang paggamit ng pampigil ng sanggol na ito hanggang sa maabot ng bata ang limitasyong ito.

Ang mga sanggol ay nasa seryosong peligro ng pagkapinsala kung sila ay haharap sa unahan ng masyadong maaga.

केवल पीछे की तरफ मुँह किये हुये स्थिति में तब तक प्रयोग करें जबतक शिशु का कन्धा कन्धे के चनिहतक न पहुँच जाए (लगभग 6 महीने की आयु पर)।

शिशु के इस सीमा तक पहुँचने तक इस शिशु प्रतबिन्ध का प्रयोग जारी रखें।

शिशुओं को समय से पहले सामने की ओर बैठाए जाने पर उन्हें गम्भीर चोट का खतरा होता है।

Da utilizzare solo in posizione rivolta all'indietro fino a quando le spalle del bambino raggiungono il marcatore di altezza della spalla (circa 6 mesi di età).

Continuare a utilizzare questo sistema di ritenuta per neonati fino a quando il bambino raggiunge questo limite.

I neonati sono a rischio di lesioni gravi se messi in posizione frontale troppo presto.

只用于后向式安装，直到婴儿的肩膀达到肩高标记（大约6个月的宝宝）在婴儿达到该座椅上限以前必须不断使用这一婴儿安全座椅。

婴儿过早乘坐前向式座椅则可能受到严重的伤害。

Na χρησιμοποιείται μόνο σε θέση στραμμένο προς τα πίσω μέχρι οι ώμοι του βρέφους να φτάσουν τον δείκτη ύψους του ώμου (περίπου 6 μηνών).

Συνεχίστε να χρησιμοποιείτε αυτό το σύστημα συγκράτησης νηπίων μέχρι το παιδί να φτάσει σε αυτό το όριο.

Τα βρέφη κινδυνεύουν με σοβαρό τραυματισμό σε περίπτωση που κοιτάζουν προς τα εμπρός πολύ νωρίς.



INTRODUCTION

TO BE USED WITH A LAP-SASH OR LAP-ONLY SEATBELT IN THE BACK OF MOST CARS WITH FORWARD FACING SEATS.

THIS RESTRAINT IS NOT SUITABLE FOR USE WHERE THE UPPER ANCHORAGE STRAP MAY FALL INTO A SPLIT IN THE SEAT BACK. (E.G. HATCHBACK OR WAGON).

CAREFULLY READ ALL THE INSTRUCTIONS FOR INSTALLATION. IN THE EVENT OF DOUBT ABOUT THE METHOD OF INSTALLATION, CONSULT BRITAX CHILDCARE OR AGENT OR A CHILD RESTRAINT FITTING STATION AUTHORISED BY A RELEVANT TRANSPORT AUTHORITY OR, IN NEW ZEALAND, THE AGENT FOR THE CAR.

No child restraint can guarantee absolute protection from injury in every crash. However, to ensure that your child gets all the protection designed into the restraint, PLEASE READ AND FOLLOW THESE INSTRUCTIONS EXACTLY and use only Babylove recommended parts and accessories.

THIS RESTRAINT MUST BE ATTACHED TO A CHILD RESTRAINT ANCHORAGE POINT IN THE CAR. REFER TO CAR OWNER'S HANDBOOK FOR LOCATION OF ANCHORAGE POINTS. REFER TO A CHILD RESTRAINT FITTING STATION IF NO ANCHORAGE POINTS ARE IN THE MOTOR CAR.

Nursery Elegance Pty. Ltd. continues to provide care for your children when travelling in motor cars with a range of child restraints suitable throughout their childhood.

Regional Road Rules may prohibit the use of this restraint in the front seat of the car. Check your Regional Road Rules for exemptions.

This instruction book can be stored under the Infant Carrier for future reference.



PAGE

- 8** WARNINGS
- 10** SHOULDER HEIGHT MARKERS & A GROWING CHILD
- 12** THE NEXT STEP
- 13** FEATURES: CARRIER PARTS
- 15** FEATURES: BASE PARTS
- 17** SUITABLE FOR USE
- 19** HOW TO SET-UP
- 22** HOW TO INSTALL
- 28** HOW TO USE
- 39** HOW TO REMOVE
- 41** HOW TO INSTALL IN AIRCRAFT
- 43** CARE AND MAINTENANCE
- 50** INSTALLATION OF CAR ANCHOR FITTING
- 55** TRAVEL SYSTEM -USE WITH STROLLER
- 58** TRAVELLING TIPS
- 59** IN CASE OF ACCIDENT



WARNINGS

- Use the restraint exactly as shown in the instructions.
- Fit the restraint firmly to the car seat.
- Fit the harness firmly to the child.
- A loose restraint or harness is dangerous.
- **DO NOT LEAVE CHILDREN UNATTENDED IN THE CAR.**
- Supervision of children is needed because they may be able to undo the buckles and/ or adjusters.
- **DO NOT USE A REAR-FACING CHILD RESTRAINT WHERE AN AIRBAG IS FITTED IN FRONT OF THE SEATING POSITION.** For other airbags, refer to the car owner's handbook for warnings and instructions.
- To ensure infant's back is evenly supported do not put more than one nappy on the baby and make sure the nappy is not thickly folded at the back.
- Do not alter or modify this restraint.
- Repairs must only be done by the manufacturer or agent.
- Do not allow the restraint to come into contact with polishes, oils, bleach and other chemicals.
- Destroy the restraint if it has been in a severe crash, even if no damage is visible.
- **DO NOT USE THIS RESTRAINT WITHOUT THE COVER.**
- Do not harness an infant wrapped in a blanket or swaddled. Any blanket or wrap must only be placed over the harness and infant.
- This child restraint is not approved for use with any connectors that connect to the car's ISOFIX low anchorages.
- Make sure the handle is latched properly every time you pick up the Infant Carrier.
- The restraint is not intended to be a substitute baby cot or bed. It is only designed to enable safe transportation of children in motor vehicles. Do not leave a baby in the restraint for long periods of time.



IMPORTANT :

Do not use the child restraint facing forwards. Do not use excessively upright or reclined.

The restraint should not be purchased or sold as a second hand item. It is recommended not to use child restraints older than 10 years as the protection in an accident may be reduced.

This restraint must be used in conjunction with a lap or lap-sash seat belt.

THIS RESTRAINT IS NOT SUITABLE FOR USE WHERE THE TOP TETHER STRAP MAY FALL INTO A SPLIT IN THE SEAT BACK OR OFF THE SIDE OF THE SEAT.

THIS RESTRAINT MUST BE ATTACHED TO A CHILD RESTRAINT UPPER ANCHORAGE POINT IN THE CAR. REFER TO CAR OWNER'S HANDBOOK FOR LOCATION OF UPPER ANCHORAGE POINTS. REFER TO A CHILD RESTRAINT FITTING STATION IF NO UPPER ANCHORAGE POINTS ARE IN THE MOTOR CAR.

Seatbelt extenders are not recommended to be used if the seatbelt is not long enough to secure the child restraint. If seatbelts are too short then seek advice from a child restraint fitter and consider their recommendations before using a seatbelt extender. If you use a seatbelt extender then ensure that the seatbelt buckle does not sit above the base moulding.

TO BE USED WITH LAP-SASH OR LAP ONLY SEATBELTS IN THE BACK OF MOST CARS WITH FORWARD FACING SEATS.

SHOULDER HEIGHT MARKERS & A GROWING CHILD



NEW BORN

Maximum Shoulder Height marker

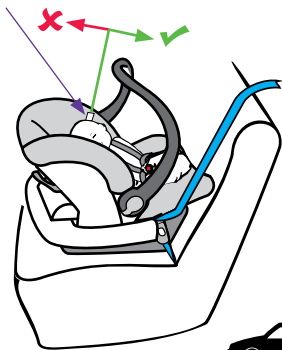

OLDER BABY

Maximum shoulder height marker

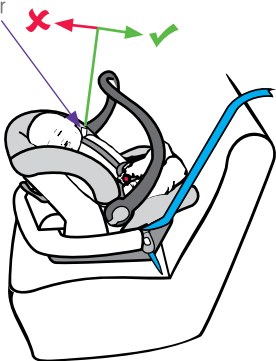

Front of Vehicle

The Carrier is not suitable for your child when their shoulders are above the shoulder height marker.

If the babies neck muscles are unable to support their head, the child should remain Rearward-facing, choose a child seat that will take larger babies in Rearward-facing.

DO NOT MOVE TO THE NEXT RESTRAINT UNTIL THE SHOULDERS REACH THE SHOULDER HEIGHT MARKER.



SHOULDER HEIGHT MARKERS & A GROWING CHILD

Shoulder height markers are provided on this restraint for a visual indication that the child is safe to ride in this restraint.

 **IMPORTANT: Follow this advice.**

MAXIMUM SHOULDER HEIGHT MARKER

DO NOT MOVE TO THE NEXT RESTRAINT UNTIL THE SHOULDERS REACH THE SHOULDER MARKER.

When the child's shoulders reach this marker, the child is now too big for this child restraint. It is now time to move to the next child restraint.

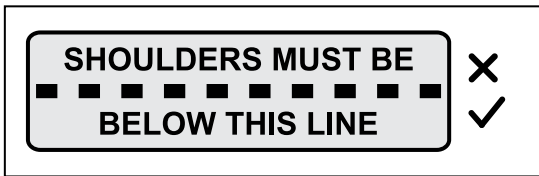

THE NEXT STEP

Next type of restraint that can be used in the car for your child.

When your child has outgrown the restraint, you can then either use:

- Convertible Child Seat, If the convertible seat is suitable for approximately 12 months then continue to keep your child rear facing until the shoulders reach the lowest marker. Then turn to forward facing until the child reaches the top marker - approximately 4 years of age. Some convertible child seats may allow for the child to remain rearward facing until 2 to 3 years of age.

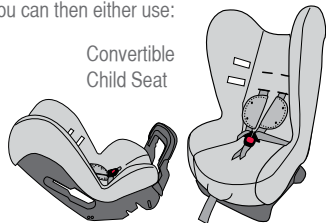

OR

- Dedicated forward facing seat with in-built harness for infants who have out grown their rear facing seat approximately 6 months. This can be used up to approximately 8 years of age with built-in harness.

Forward facing,
Harnessed Child
Seat

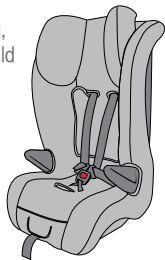

OR

- Convertible booster seat with in-built harness that faces forward- for children who have out grown their rear facing seat approximately 6 months. This can be used up to approximately 4 years of age with built-in harness and then be converted to a booster seat and used up to approximately 8 years of age.

Convertible
Booster Seat

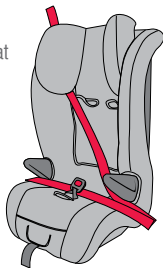

FEATURES: CARRIER PARTS

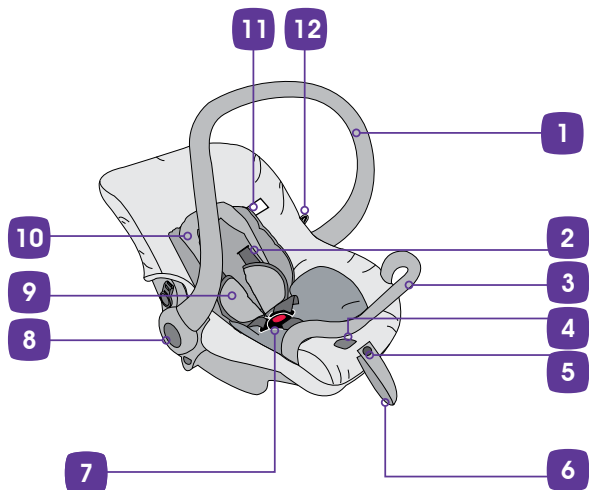

1. Carry Handle
2. Shoulder Straps
3. Front Stabilising Bar
4. Adjuster and Harness Adjuster cover
5. Harness Adjuster Strap Storage
6. Harness Adjuster strap
7. Harness Buckle and Tongues
8. Handle Release Button
9. Shoulder Pads
10. Padded Insert
11. Shoulder Height Marker
12. Buckle Tongue Holder



FEATURES: CARRIER PARTS

- 13. Instruction Book Storage Pocket
- 14. Release Lever For Stroller and Base
- 15. Top Tether Strap Guides
- 16. Metal Strap Connector
- 17. Base Latch
- 18. Stroller Latch
- 19. Canopy Attachment Points

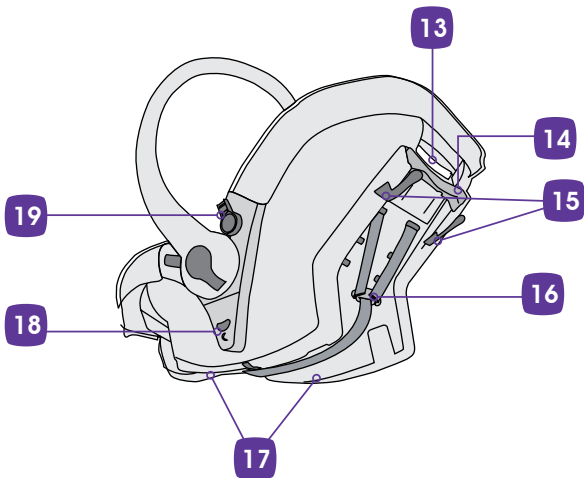



FEATURES: BASE PARTS

- 20. Attachment Clip
- 21. Top Tether Strap Adjuster
- 22. Top Tether Strap
- 23. Retaining Strap connected to base
- 24. Adjustable Recline Foot (4 position)
- 25. Recline Foot Adjustment Handle
- 26. Car's Upper Anchorage fitting
- 27. Top Tether Storage Pocket

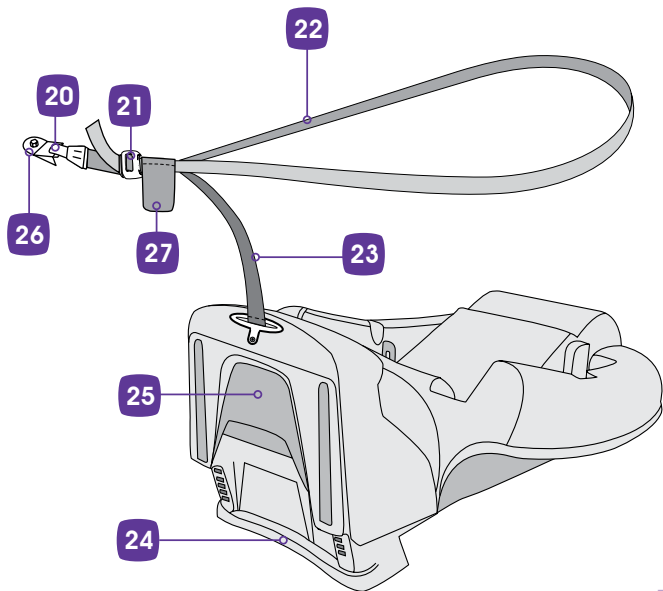

FEATURES: BASE PARTS

- 28. Vehicle Seatbelt Clip
- 29. Carrier Latching Points
- 30. Rearward-Facing Belt Path Label (shown in blue)
- 31. Vehicle Seat Belt Path
- 32. Seat Belt Routing Tabs

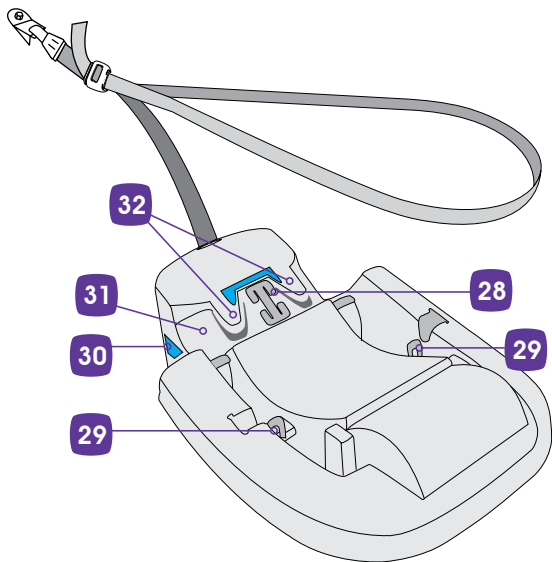



SUITABLE FOR USE

To be used only in a rearward-facing position until the infant's shoulders reach the shoulder height marker (approximately 6 months of age).

Continue to use this infant restraint until the child reaches this limit.

Infants are at risk of serious injury if they face forward too early.

If the baby's neck muscles are unable to support their head, then the child should remain rear-facing, choose a restraint that will suit larger babies in a rear-facing mode.

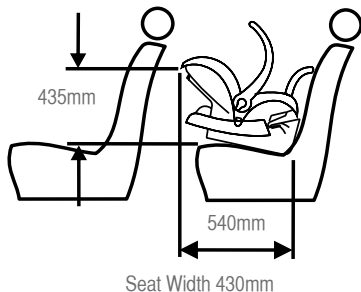

To ensure that the space is sufficient, the purchaser should check the measurements between the vehicle's rear and front seats in which the child restraint is intended to be used.

Ensure babies and toddlers are adequately shaded from direct sunlight through side or rear windows.

Check the car is ventilated by opening windows or using the car's ventilation system taking in external air. Recirculation setting is not suitable for providing ventilation.

SUITABLE FOR USE



WARNINGS

THE TOP TETHER STRAP MUST ALWAYS BE FITTED WHEN THE CHILD RESTRAINT IS USED IN A VEHICLE.

Do not use the restraint without the top tether strap correctly attached.

The top tether strap must be attached to an anchorage point using an extension strap if necessary.

The Infant Carrier may just touch the front seat, but must not in such a way that the installation angle is affected.

Do not recline the seat excessively, it must be installed at the correct angle (see page 23).

Do not allow the front seat to alter the installed position of the restraint, It is permissible to allow the restraint to touch the seat on front of it.

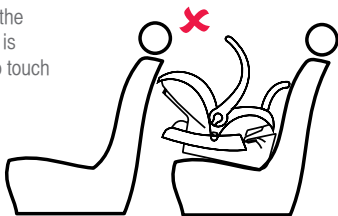

Do not use on any vehicle seat which faces sideways or rearwards.

DO NOT USE A REAR-FACING CHILD RESTRAINT WHERE AN AIRBAG IS FITTED IN FRONT OF THE SEATING POSITION. For other airbags, refer to the car owner's handbook for warnings and instructions.

Seat belt extenders should not be used if the seat belt is not long enough to secure the child restraint. If seatbelts are too short the advice should be sought from a child restraint fitter and their recommendations considered before using a seatbelt extender. If they are used then the buckle must sit above the base moulding.



HOW TO SET-UP

REMOVING CARRIER FROM BASE

- A. Press the handle button (on both sides) and rotate the handle to upright “carry” position. Ensure the handle is locked, and it is safe to lift the Carrier.

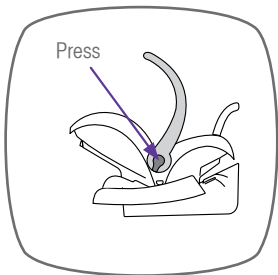

- B. Grasp the carry handle and pull the release lever at the back of the Carrier, and then lift the Carrier from the Base.

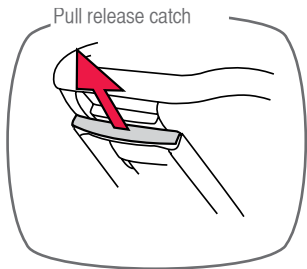

HOW TO SET-UP

ADJUSTMENT OF HANDLE POSITION

- A. The Carrier features a sturdy carry handle. At the side of the handle there is a handle release button on each side which controls the three positions of the handle. The “carry” position is upright and suitable to carry the baby. Ensure the handle is locked, and it is safe to lift the Carrier.
- B. To convert from “carry” to “access” position, press the handle release button on each side and rotate the handle towards the back of the Carrier. Rotate until the handle locks into the next position. This position ensures the handle does not interfere with the attachment of the upper anchorage strap or removal of the baby.
- C. To convert to a “non-rocking” position press both handle release buttons and rotate the handle to the next position. Ensure the handle is locked in position securely.
- D. Press the handle release buttons to reposition the handle to suit your needs. The handle can also be in any position when the carrier is installed in the car.

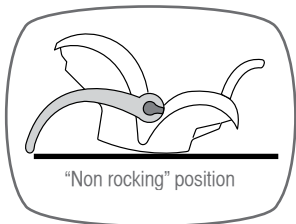
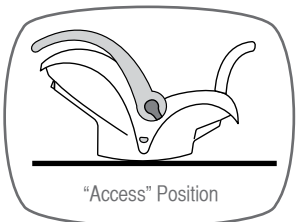
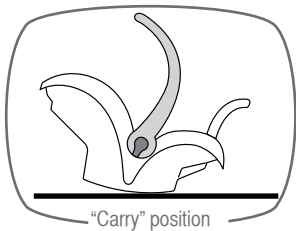

IMPORTANT:

Make sure the handle is engaged properly every time you pick up the Carrier.



HOW TO SET-UP

TO REMOVE/FIT CANOPY

- A. To connect, feed the canopy stay into the mounting on the side of the Carrier.
- B. Connect two press studs on the back of canopy to the cover.
- C. The Canopy can be rotated to cover the baby or opened by rotating to the desired position. When fully open the canopy locks in position.
- D. To remove the canopy press the tab and rotate the bow outwards. When removing take care not to bend the bow and canopy attachment points.

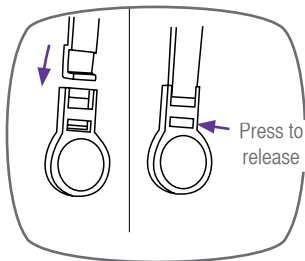
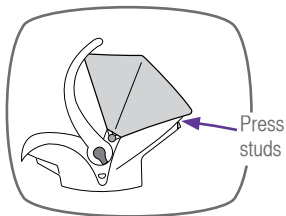

HOW TO INSTALL

Consult the car owner's handbook for location of anchor fittings or anchorage points. Some vehicle manufacturers have an anchor fitting fitted in the car.

If there is no child restraint anchor fitting or child restraint anchor point refer to page 50 for the installation of the anchor fitting as well as the use of extension straps.

An anchor fitting is required to attach the upper anchorage strap to fully install the Carrier to the car. The upper anchorage strap must be used with this carrier when used in the car.

For installing the Base to the car, select a seating position with a child restraint anchor fitting directly behind the seating position.

INSTALLING THE BASE TO THE CAR

- A. Place the base and Carrier on vehicle seat in a seating position where a child restraint anchor fitting is installed. The Level Indicator Line needs to be level with the road, (i.e. parallel with the road surface). Check and adjust the recline angle of the base if necessary as follows.

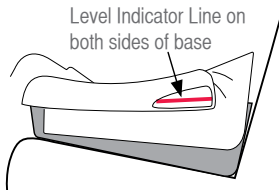



HOW TO INSTALL

B. If your car's seat is contoured then you may need to adjust the angle of the base so your baby is not too upright.

The recline angle may be altered using the four position adjustment foot located at the stabilising bar end of the base. To adjust, pull recline foot adjuster to release and lower or raise the angle adjustment foot to the desired position. Place in the vehicle seating position and recheck the Level Indicator Line.

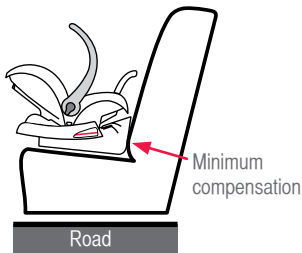
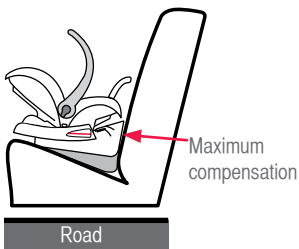
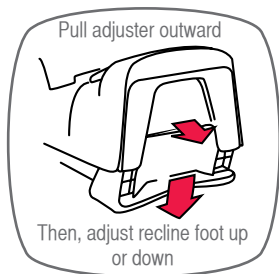

HOW TO INSTALL

- C. For car's with flat seats, some packing (such as firmly rolled up nappy or towel) may be required to get a better angle. The base must contact the car's seatback.

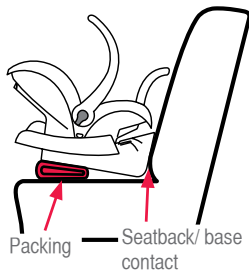

- D. Place the base into the car in the selected seating position. Ensure the base is positioned against the car seatback.

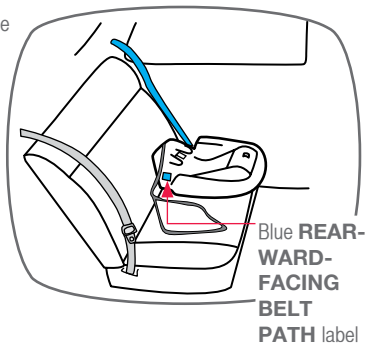

- E. Thread the vehicle lap belt under the tabs and through the seat belt clip, Pull the sash belt to remove slack.
- F. Engage the seat belt buckle and pull the sash belt to achieve a tight fit whilst pressing on the base.

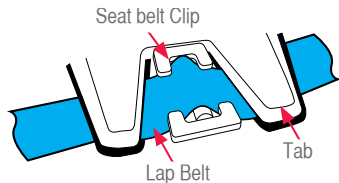



HOW TO INSTALL

- G. Feed the sash belt under the tabs and through the Seatbelt Clip

Check that the Base is securely held. If it is not secure, retighten the seat belt or try another position in the vehicle. Some sideways movement is common and acceptable.

- H. Recheck the installation angle, and adjust if necessary.

NOTE: When the Base is secured with a Lap/Sash Belt both the Lap and Sash belts need to pass through the Seat belt Clip.

If using a lap only seatbelt thread through the tabs and seatbelt clip. The free end of the lap belt does not need to be threaded through the seat belt clip.

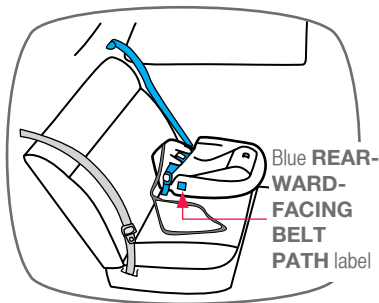
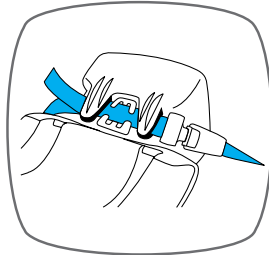
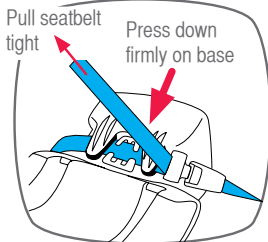

HOW TO INSTALL

- J. Some car seats do not provide enough support to hold the base up at the required angle to enable the Carrier to be connected to the Base. Use the adjustable foot to achieve the level. See page 23.

If extra support is required to achieve the desired level then a tightly rolled towel can be used.

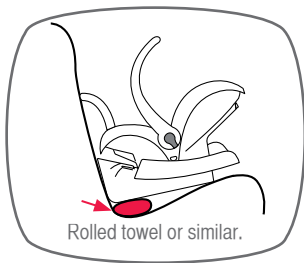

IMPORTANT:

Always anchor the base with a vehicle belt, even when the restraint is not installed on it. An unanchored base can injure passengers in a sudden stop or accident.

INSTALLING UPPER ANCHORAGE STRAP

- A. Locate the child restraint anchor fitting in the car that is directly behind the seat location in the rear seat you have chosen. Refer to the car owner's manual for the location (If there is no anchor fitting then refer to page 48 for instructions in adding an anchor fitting.) Connect the Upper Anchorage Strap Attachment Clip to the Anchor Fitting.

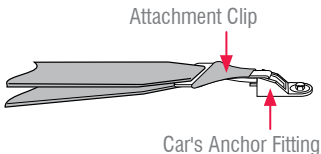



HOW TO INSTALL

Lengthen the strap by pressing the adjuster button (1) and pull the strap (2) so that the strap is ready to attach to the Carrier.

THIS TOP TETHER STRAP MUST ALWAYS BE FITTED WHEN THE INFANT CARRIER IS USED IN THE CAR

Fully press Adjuster Button (1) while pulling Top Tether Strap (2) to lengthen.

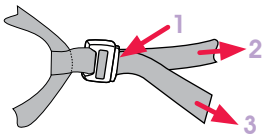

- B. While the Carrier is out of the car, store the upper anchorage strap between the stabilising bar and the car seat back so that it will be ready for use when the Carrier is put back in the car.



IMPORTANT :

Always secure the loose end of the top tether strap to prevent it hanging out of the car or being accessible by the child.

DO NOT USE THE CHILD RESTRAINT WHERE THE TOP TETHER STRAP MAY FALL INTO A SPLIT IN THE SEAT BACK OR OFF THE SIDE OF THE SEAT.

Always ensure that the car seatbelt and top tether strap are firmly restraining the restraint on the vehicle seat.

ALWAYS ATTACH TOP TETHER HOOK AND REMOVE SLACK IN THE TOP TETHER STRAP.



CAUTION:

CHILDREN CAN BE INJURED OR RESTRAINTS AND TOP TETHER STRAP DAMAGED BY UNSECURED CARGO IN A COLLISION. SECURE OR REMOVE HAZARDOUS CARGO BEFORE USING THIS CHILD RESTRAINT.

HOW TO USE

SETTING UP THE HARNESS

- A. Sit the Carrier on a flat ground or the floor with the handle rotated fully back to prevent rocking.
- B. Release the buckle and lengthen the Harness Straps by pressing Harness Adjuster (under the flap) while grasping both Shoulder Harness Straps and pulling out fully.

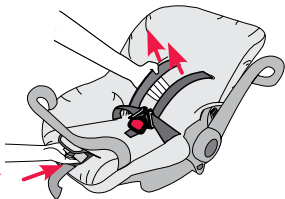

Lift the Harness Adjuster up and pull the Harness Straps to slacken.

- C. Move the two harness tongues to the outer extents of the Carrier and connect to the Harness Tongue holders. Move the harness buckle towards the Harness Adjuster.

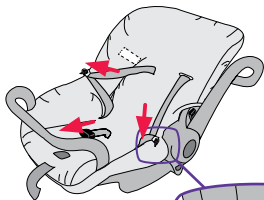

Buckle Tongue Holder on both sides of the Carrier. Push tongue inwards to engage.

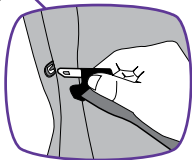



HOW TO USE

D. Place baby into Carrier lying on its back so that the buckle is between the baby's legs.

Correct fitment of the harness is very important as it restrains the baby in the Carrier. The harness must fit firmly around upper torso of the baby and be positioned so as to leave the baby's arms and legs free.

This Carrier needs to be used until the baby reaches the shoulder height marker. It is acceptable for the legs to be bent to fit.



E. The Carrier is fitted with three shoulder strap positions. As the baby grows, the shoulder straps must be moved to higher slots.

The shoulder straps must be in the slots which are nearest to the child's shoulders, but not lower than the child's shoulders.

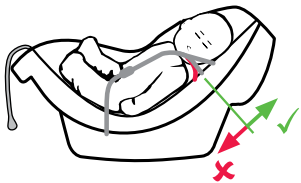

HOW TO USE

1. Upper shoulder strap slots
2. Medium shoulder strap slots
3. Lower shoulder strap slots
4. Shoulder harness strap
5. Harness tongues & buckle
6. Lap strap slot
7. Crotch strap slot
8. Maximum Shoulder Height Marker
9. Harness Adjuster (under cover flap)
10. Adjuster Strap

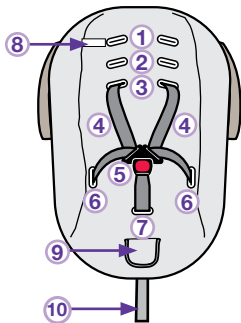

If the baby is new born you will need to use either slot 2 or 3. With the baby in the carrier, check that the slot is just above the baby's shoulder. If the strap is not in that slot then change the slot as described on the next page. If the slot is just above the shoulders then go to page 33.

- F. At the rear of the Carrier, remove one of the harness shoulder straps from Metal Strap Connector by slipping strap through open slot. The Metal Strap Connector is shown in diagram right.

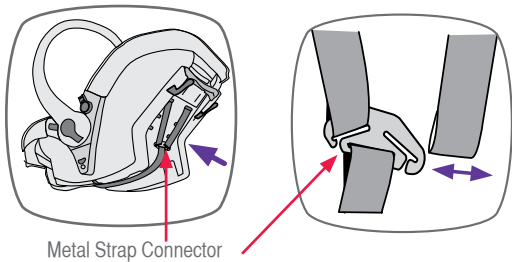



HOW TO USE

- G. Pull the shoulder strap through slot.
- H. Insert the shoulder strap through the Carrier slot which will position the shoulder strap level with or above the baby's shoulder. Ensure that the shoulder strap passes through matching slots in the cover and seat shell.

If a Padded Insert is used then that will need to be re-positioned and the strap re-inserted when changing the slot position.

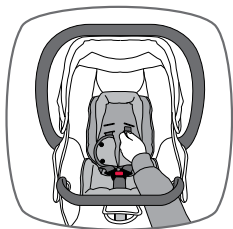

IMPORTANT:

Do not use the carrier with the harness shoulder straps set at different heights or fed through mismatching slots. Ensure the harness straps are not twisted and that all straps are secured by pulling each harness strap.

HOW TO USE

- I. Ensure there are no twists in the straps.
- J. Thread the shoulder strap over the bar and connect it to the Metal Strap Connector at rear of Carrier.
- K. Repeat for the other shoulder strap. It is better to change one strap at a time so that the other strap will be a guide for re-assembly.



IMPORTANT :

- Always adjust the height of the shoulder straps as the child grows
- Do not use the carrier with the harness shoulder straps set at different heights or fed through mismatching slots.
- Ensure the harness straps are not twisted and that all straps are secured by pulling each harness strap.

FOR SMALL BABY

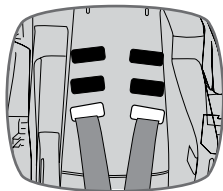

FOR GROWING BABY

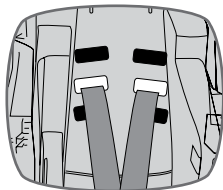

FOR LARGER BABY

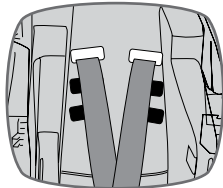

HOW TO USE

PLACING BABY IN CARRIER

When positioning baby into Infant Carrier make sure baby's back is fully supported onto the flat section and the baby's nappy area (bottom) is resting in the bottom curvature as shown. It is recommended that bulky nappies are not used when baby is travelling in the Infant Carrier as they can cause incorrect positioning of the baby's back in the Infant Carrier.

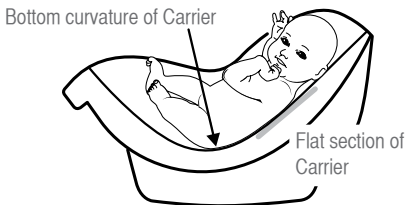

- A. Loosen Harness Straps by pressing the Harness Adjuster while grasping both the Shoulder Harness Straps and pulling out the desired amount of slack.

Press the Harness Adjuster and pull Harness Straps to loosen.

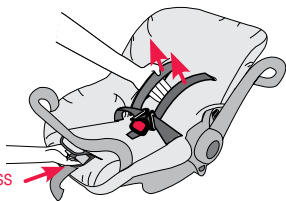

HOW TO USE

- B. Move the two harness tongues to the outer extents of the infant carrier, into the Buckle Tongue Holders (if fitted). Move the harness buckle towards the Harness Adjuster.

Buckle Tongue Holder on both sides of the Carrier. Push tongue inwards to engage.

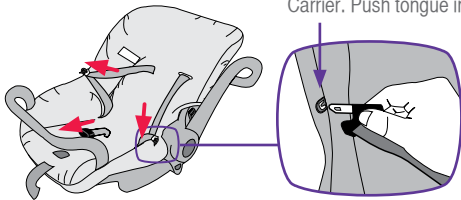

- C. Place baby into Infant Carrier lying on its back so that the buckle is between the baby's legs. Ensure that baby's arms and legs are free. Make sure baby is dressed to allow the Harness Buckle to be pulled up between baby's legs e.g. a jumpsuit.

NOTE:

1. Discontinue using the Padded Insert when shoulder straps are in the top slots or if it causes discomfort to baby.
2. Correct fitment of the harness is very important as it restrains the baby in the Infant Carrier. The harness must fit firmly and be positioned so the baby's arms and legs can move freely.

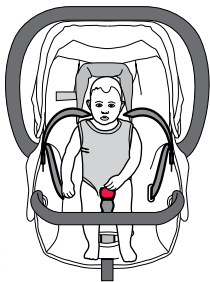

CAUTION:

Do not harness an infant wrapped in a blanket or swaddled as this increases the risk of ejection and injury or death in a crash. The harness needs to fit firmly to the baby, any blanket or other covering may be placed over the harness after the harness is adjusted. Arms and legs must be free and not bound. The legs must sit on each side of the crotch strap.



HOW TO USE

SECURING BABY IN INFANT CARRIER

- A. Place each arm through each shoulder strap of the harness. Position the buckle of the crotch strap as shown right.



- B. Fit either harness tongue into the Harness buckle followed by the other tongue until a click is heard. If the second tongue does not engage - press the red button and re-insert the tongues. Check secure engagement by pulling harness straps.

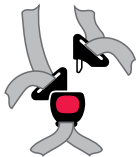
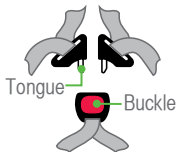

CAUTION:

The end of the harness adjustment strap is connected to the cover to avoid tripping over the end. Ensure the harness adjustment strap hook is attached when carrying the carrier (see page 36).



HOW TO USE

- C. Ensure slack is removed from the lap straps by pulling the shoulder harness straps through the buckle tongues, then pull the Harness Adjustment Strap to remove the slack in the harness, adjusting to a firm but comfortable fit. Make sure the baby's arms and legs are free and the crotch strap is between the legs. Check there is no slack in the harness straps.

Do not use the restraint if straps do not tighten. Contact your local authorised service agent for repair.

- D. Attach the press stud at the end of the strap to the cover to prevent tripping over the strap.

! WARNING: DO NOT LEAVE CHILDREN UNATTENDED IN THE CAR.

The end of the harness adjustment strap is connected to the cover to avoid tripping over the end when carrying the Carrier. Ensure the harness adjustment strap hook is attached when carrying the carrier.

Pull Harness Straps through the buckle in direction of arrows



Pull Harness Adjustment Strap to remove slack.

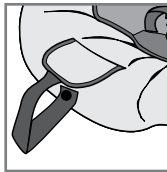

! CAUTION: A LOOSE HARNESS IS DANGEROUS

HOW TO USE

PLACING BABY & CARRIER IN BASE

A. Position the Carrier over the top of the installed base. Make sure the Harness Adjustment Strap is not caught between Carrier and Base then lower the Carrier into position.

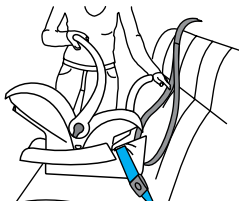

B. Push down on the Carrier until an audible click is heard. Pull up on the Carrier to ensure it is correctly locked into position.

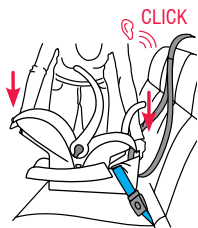

IMPORTANT:

Lift again to check engagement.

C. The handle may be rotated into other positions if needed.

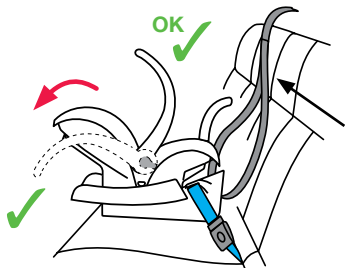

Upper Anchorage strap ready to be fitted to Carrier.

HOW TO USE

- D. Engage the upper anchorage strap attachment clip to the car's anchor fitting, if not already connected.

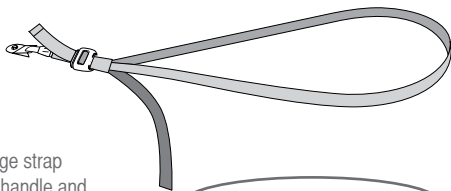

- E. Feed the Upper Anchorage strap through the inside of the handle and over the restraint, engaging with the locating slot guides in the front of the Carrier as shown.

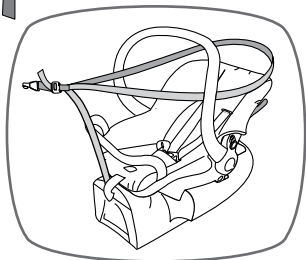

- F. Adjust the Upper Anchorage Strap by pulling as shown below to remove any slack in the straps. Do not over tighten, such that the base starts to lift away from the vehicle seat. Remove slack only.

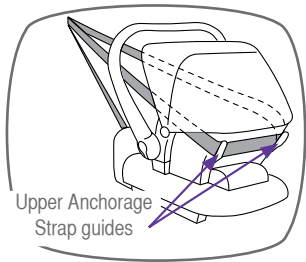
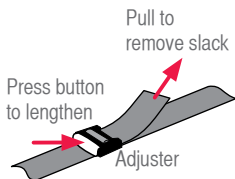

IMPORTANT:

The Top Tether strap must be fitted at all times when the baby is in the car.

HOW TO REMOVE

REMOVING BABY & CARRIER FROM BASE

- Loosen the top tether strap by fully pressing the adjuster button while pulling the top tether strap. Ensure that the adjuster does not fall onto the baby.
- Remove the top tether strap from the locating slot guides in the Carrier. Place the top tether strap behind the stabilising bar.
- Rotate the Carry Handle to the “carry” position and ensure it is locked correctly before lifting.
- Grasp the handle with one hand, then release the Carrier release catch with the other hand. With the carrier released, raise the Carrier away from the base, you may need two hands to lift the carrier out of the car. Place feet apart and use bent legs to lift the carrier to avoid back injury.

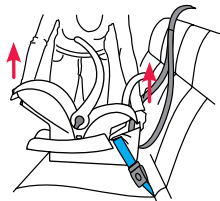

CAUTION:

Do not lift or carry the Carrier by the front stabilising bar.



- When the Carrier is clear of the base, carefully remove it from the car.
- Always keep baby secure in the integral harness when carrying.

Ensure the adjustment strap press stud is connected to the cover, see page 36.

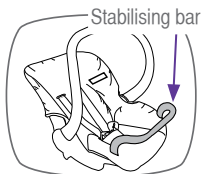

CAUTION:

The end of the harness adjustment strap is connected to the cover to avoid tripping over the end when carrying the Carrier. Ensure the harness adjustment strap hook is attached when carrying the carrier.

HOW TO REMOVE

REMOVAL OF BABY FROM CARRIER

- A. Rotate the carry handle to either the “access” or “non-rocking” position and ensure the Canopy is fully open.
- B. Press the Harness Adjuster while pulling shoulder straps to loosen the harness.
- C. Press the red button on Harness Buckle then both Harness Tongues will be released.
- D. Feed the baby’s arms through each side of the Harness and place the straps on each side of the carrier clear of the baby. Lift the baby out of the Carrier.

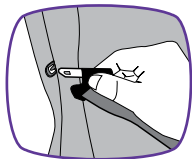

NOTE:

Once the baby gets heavier you may wish to leave the carrier in the car. In this case you will need to disconnect or loosen the upper anchorage strap before removing the baby.

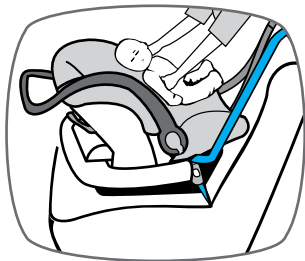
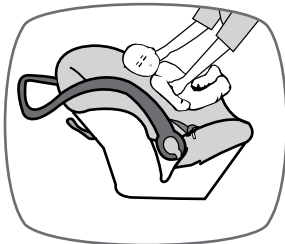

HOW TO INSTALL IN AN AIRCRAFT

HOW TO INSTALL USING AIRCRAFT LAP BELT

The Infant Carrier without base is suitable for use on aircraft.

The Infant Carrier must be used in accordance with the aircraft operators procedures, and any directions from the aircraft operator, pilot or crew.

The Infant Carrier may not fit in smaller aircraft.

Inform the aircraft operator that a child restraint is intended to be used on the aircraft when booking the flight as the child restraint may not be suitable for use in that operator's specific aircraft.

Follow the instructions of the flight crew or pilot.

For use of the child restraint in cars in countries other than Australia and New Zealand, The user should consult the country's local authorities, car hire companies, car insurance companies, etc. for advice. The child restraint may not be acceptable for use in all cars.

FIT THE INFANT CARRIER TO THE AIRCRAFT SEAT

You do not need the base or top tether strap on an aircraft. We recommend that you check it in with your luggage.

- Position the infant carrier rearward facing, align it centrally within the allocated seating position. If possible, lift the armrests out of the way to improve access to installing the aircraft lap belt and to suit the width of the carrier.
- Place handle in "non-rocking" position, that is, fully backwards. Carefully remove cover on the side to reveal **AIRCRAFT REARWARD-FACING BELT PATH** label marked in green.

NOTE: Never use this path in a car

- Fully lengthen lap belt. Thread the lap belt into **AIRCRAFT REARWARD-FACING BELT PATH** lap belt path (green marker) as shown, ensuring that lap part is below the hook as shown, on each side. Engage lap belt buckle and tongue.

AIRCRAFT REARWARD-FACING BELT PATH marked in green.

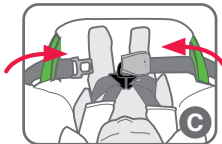
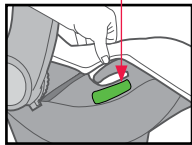

HOW TO INSTALL IN AN AIRCRAFT

- D. Push down on the infant carrier and remove all slack from the lap belt. Pull belt strap to tighten, ensure a firm fit of the infant carrier to the seat.

Do not use this restraint with aircraft seatbelt that contain airbags, unless the aircraft operator can disable them.

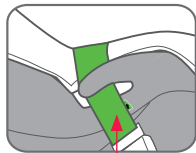

Ensure lap belt is under the hook on each side

The infant carrier base may be included with 'checked in' luggage (for use after flight). Aircraft label is located on the underneath of the infant carrier. It demonstrates suitability for use on aircraft.

Ensure the top tether is rolled up and stored in the pocket provided.

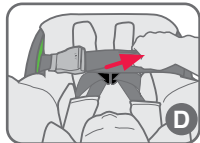

Remove slack



This Child Restraint System meets the standards for use in aircraft as recommended by the Civil Aviation Safety Authority of Australia and the Civil Aviation Authority of New Zealand.

Only to be used on aircraft with the permission of the aircraft operator, pilot and crew.

SUITABLE FOR REAR FACING USE

The top tether strap is not required to be used onboard aircraft and should be stowed securely.

CARE AND MAINTENANCE

REGULAR CARE OF THIS RESTRAINT:

Please check the following items regularly to ensure the safety of your child:

- A. Check the webbing straps for fraying,
- B. Check there are no cracks in moulding,
- C. Check the harness adjuster is operating and is clamping the webbing,
- D. Ensure the buckle is free of fluff, liquid or other matter that may enter the buckle slots. Clean the buckle if it is sluggish to engage. See next page.
- E. If any part of the restraint is cracked, broken or not operating seek repair immediately - contact Britax Customer Service 1300 131 477

CLEANING CAR SEAT

Use only mild soap and water to clean all metal and plastic parts of the restraint. Do not use chemicals or cleaning agents.

HARDWARE: Use only mild soap and water to clean all webbing, metal and plastic parts of your child's restraint, using a damp cloth.

Do not use chemicals or cleaning agents. Do not try and place any hardware into a washing machine.

STRAPS AND HARNESS: We only recommend that you spot clean the straps/harness with a damp sponge. The harness straps can be soaked, however they must be thoroughly dried without excessive heat (never tumble dry). The harness straps should not be placed in a washing machine as this may cause damage to the stitching or even damage your washing machine.

COVER: The restraint has a flame retardant cover which is removable for cleaning, please clip the hook and loop together on the cover and seat pad (if supplied) to prevent any damage to the cover when washing. Cleaning instructions are on the care label attached to the cover. For machine washable covers, use gentle cycle, cold water only, rinse well and dry on a flat surface. Do not tumble dry, do not bleach or dry-clean. May be hand washed. Follow the care label on the cover.

CARE AND MAINTENANCE

BUCKLE OPERATION

To ensure the buckle remains operational the inside of the buckle must be kept free of liquids, sand, dirt, fluff, food or similar substances. If the buckle is not operating or you do not hear a strong audible click when second tongue is inserted then the buckle needs to be washed or replaced. The buckle is fully engaged when both tongues are inserted. Contact Customer Service for assistance.

TO CLEAN HARNESS BUCKLE:

If sticky liquids such as baby formula, fruit juice, etc. get inside your harness buckle, it may become sluggish. An indication of a sluggish harness buckle is that you cannot hear a click when engaging the last harness tongues.

To restore the harness buckle to good working order it needs to be cleaned as follows:

- Remove the harness buckle from the restraint:
From the underside of the restraint pull each crotch strap 3-bar slide, turn the 3-bar slide on its side and push back through the slot.
- Place the harness buckle under warm (max. 40 degrees Celsius) running water as shown below. Let the water run through the mouth of the buckle for five minutes. Check the harness buckle is clean by engaging the harness tongues and buckle several times until you hear a click.
- If you still cannot hear a strong audible click then repeat the cleaning process several times.
- Refit the harness buckle to the restraint ensuring the red button facing outwards and the 3-bar slide is fed through the same slots.

If the harness buckle cannot be returned to its original working condition then contact Nursery Elegance Customer Service - 1300 131 477.

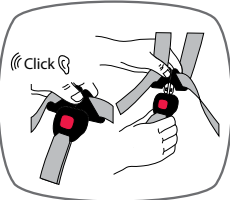
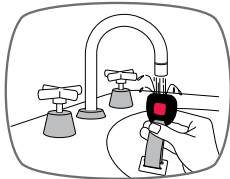
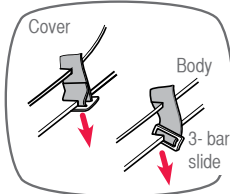

CARE AND MAINTENANCE

COVER (style may vary)

The restraint has a flame retardant cover which is removable for cleaning. Cleaning instructions are on the care label attached to the cover. If fluffy cover is fitted then washing the cover prior to use will remove excess fluff.

The cover has been designed to protect your child when seated in the restraint. Care should be taken if children either eat or drink while in the restraint as some food or drink products may cause damage or marking to the cover. Wash or clean immediately. Do not pull sticky items from covers as the cover may be damaged - soak in water and gently remove.



IMPORTANT:

Do not pull sticky items from covers as the cover may be damaged - soak in water and gently remove.

The seat cover and accessories must not be replaced with any other than the one recommended by Nursery Elegance Pty Ltd, because the cover is an integral part of the child Carrier and how it performs. The child Carrier must not be used without the cover and the padding provided.



VERY IMPORTANT:

Only replace the cover with Nursery Elegance supplied replacement cover with identical shoulder height markers or a replacement cover meeting AS/NZS 8005.

CARE AND MAINTENANCE

TO REMOVE THE COVER

- With the Carrier on the ground or the floor, remove the Shoulder Pads and any other accessories.
- Disconnect the shoulder harness straps from the Metal Strap Connector. Refer to page 28. Then pull the shoulder straps out of the shoulder slots in the carrier, cover and Padded Insert.

Note which shoulder strap slots you were using.

- Remove the Padded Insert
- Lift the cover around the rim of the Carrier at the harness adjuster end, feed the crotch buckle through the slot in cover and pull the harness adjuster strap out of the slots.
- Feed the shoulder harness straps and tongues through lap strap slots in the Cover only. There is no need to completely remove the harness straps from the Carrier.
- Remove the cover completely for cleaning.

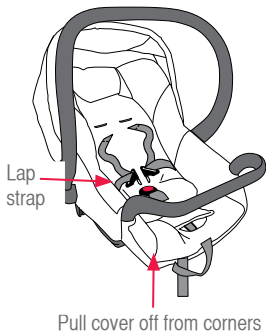

CARE AND MAINTENANCE

TO REPLACE THE COVER

- A. Place the cover over the Carrier.
- B. Feed the shoulder harness straps through lap strap slots in cover. Ensure that there are no twists in all straps at the back of the Carrier.
- C. Feed the crotch buckle as well as the harness adjuster strap through the slots in the cover.
- D. Fully fit the cover ensuring all slots in the cover line up with the slots in the carrier. Fit the Padded Insert if required.
- E. Feed the shoulder harness straps through the shoulder strap slots in cover and then in through the Carrier. If you forget which shoulder strap slots were used refer to page 28 for correct shoulder harness position for your baby. Feed shoulder straps through the Padded Insert if required. Attach the shoulder harness straps to the Metal Strap Connector.
- F. Engage shoulder harness tongues and crotch buckle to ensure there are not twists in the harness straps. Pull to check harness is attached.
- G. Insert the cover wings on the edge of the carrier and connect the press studs next to the stabilising bar on the trim.



Pull elastic cover over Carrier

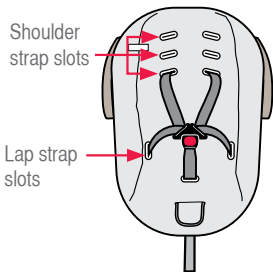

Shoulder strap slots

Lap strap slots

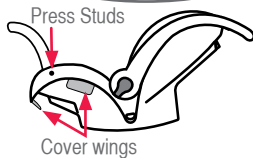
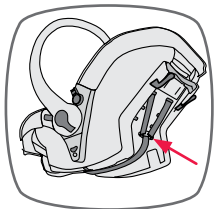

Press Studs

Cover wings

ACCESSORIES

Use of aftermarket accessories, that is, accessories not provided with this child restraint can reduce the safety of the child restraint and may cause injury or death. Always follow the instructions covering the use of accessories in this section or the instructions provided with accessory. If an aftermarket accessory is used that is not recommended by Babylove then ensure that the accessory is compliant with AS/NZS8005 and stated as suitable for use with this child restraint.

The following instructions apply to accessories that may be supplied with this restraint at point of purchase. If not, a variety of Nursery Elegance accessories are available from various retailers of Nursery Elegance products.

PADDED INSERT (style may differ)

Some models have a separate Padded Insert inside the Carrier for additional comfort.



CAUTION:

Shoulder straps must pass through slots in the insert.

Failure to do this might result in the shoulder straps not holding the child securely.

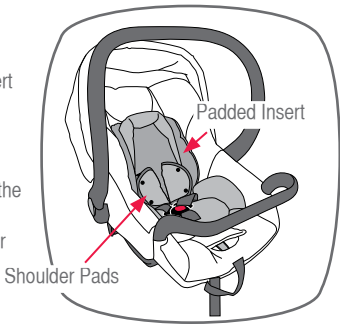

SHOULDER PADS (Where fitted)

A. The shoulder pads may require release by press studs. If fully fitted to the shoulder strap then you will need to disconnect the shoulder strap as described on page 19.



ACCESSORIES

EXTRA BASE

There are Babylove Series BL620A/2013 Extra Bases available as a separate purchase for a second car. These bases allow the Carrier to be easily and quickly switched between cars. The Extra Base has the same installation requirements as the Base in these instructions.

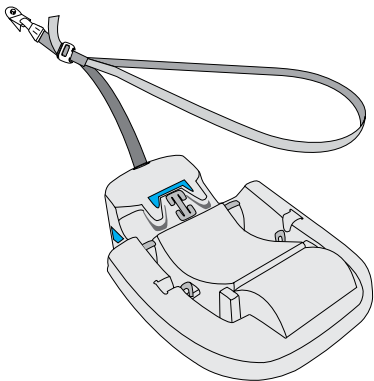

OTHER ACCESSORIES

Only use accessories designed for this product and recommended by Nursery Elegance Pty Ltd.

INSTALLATION OF CAR ANCHOR FITTING

Consult the vehicle owner's handbook for location of anchorage fittings or anchorage points and the possible use of spacers. Some vehicles may have an anchor fitting installed by the vehicle manufacturer. If anchorage points cannot be found refer to car manufacturer or local child restraint fitting station or traffic authority for optimum position of anchorage point and the use of spacers.

TOP TETHER STRAP



IMPORTANT:

THE ATTACHMENT CLIP COVER MUST ALWAYS BE USED AS IT PREVENTS THE RISK OF INCORRECT FITMENT OF THE ATTACHMENT CLIP TO THE ANCHOR FITTING. ALWAYS ENSURE THAT THE ATTACHMENT CLIP IS CORRECTLY ENGAGED TO THE ANCHOR FITTING AND NOT HOOKED OR FITTED TO ANY OTHER OBJECT BEFORE EACH USE OF THE RESTRAINT. THIS IS ESPECIALLY IMPORTANT IN VEHICLES SUCH AS STATION WAGONS, VANS, HATCH BACKS OR VEHICLES WITHOUT A FIXED PARCEL SHELF, SINCE THE ANCHOR POINT IS USUALLY NOT VISIBLE.

IMPORTANT INSTALLATION NOTE:

In some vehicles the anchor fitting in the rear vertical panel can only be installed in one way. Please refer to vehicle owner's handbook or a child restraint fitting station for correct method.

CAR INSTALLATION ACCESSORIES

(From retailers of Britax Safe-n-Sound products)

EXTRA ANCHOR KITS: Available for using the restraint in additional cars.
Re-order no: 0038

EXTENSION STRAPS: May be required for cars without a fixed parcel shelf.
Re-order no: 0035 (length 300mm) or
0036 (length 600mm)

INSTALLATION OF CAR ANCHOR FITTING

Extension Strap distance to be measured.
Length 300mm (Use Britax Safe-n-Sound part 0035).
Length 600mm (Use Britax Safe-n-Sound part 0036).
Available from all major child restraint retailers.

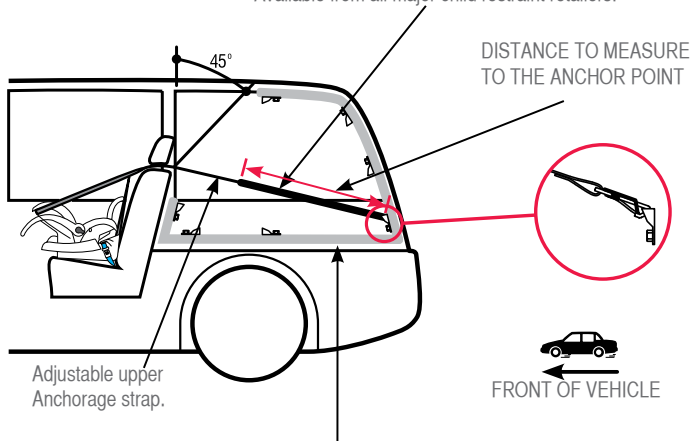

The shaded areas of this diagram illustrate the possible locations of the anchor fitting. Within each shaded area is an anchor fitting showing the correct way to install the fitting. Ensure the anchor fitting is aligned as illustrated unless stated otherwise in the vehicle owner's handbook.

INSTALLATION OF CAR ANCHOR FITTING

IF THE CAR IS FITTED WITH CHILD RESTRAINT ANCHORAGE POINT

Locate the anchorage point behind the rear seating position (consult the car owners handbook for the location of the available anchorage points). The anchorage point should be directly behind and central to the restraint. Remove thread plug from the parcel shelf/floor/roof, etc. and install attachment bolt and fitting as shown in Fig 1.

CAUTION: DO NOT OVERTIGHTEN ANCHOR BOLT. OVERTIGHTENING MAY FRACTURE OR BREAK BOLT. MAXIMUM TORQUE IS 20 Nm (14.75 ft.lb.)

Note: Minimum of five full turns of attachment bolt is required before tightening force is applied.

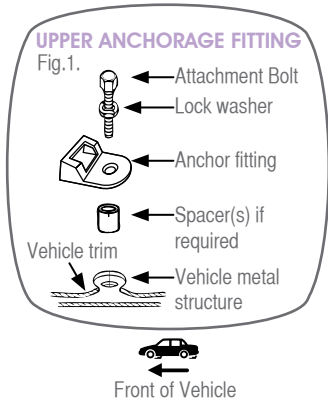

INSTALLATION OF CAR ANCHOR FITTING

IF THE CAR IS NOT FITTED WITH CHILD RESTRAINT ANCHORAGE POINTS

For Sedans only - Drill 9mm diameter hole in the parcel shelf on the centre line of the seating position as shown in Fig 3. Before drilling the hole, check the underside for accessibility. Install the attachment bolt as shown in Fig 2.

For vehicles other than Sedans

- In Australia, consult your nearest child restraint fitting station or traffic authority for vehicle inspection to find the best, correct position for the placement of the anchorage point, and for the correct attachment bolt length and use of spacers. In New Zealand, consult the agent for the vehicle.

Note to Queensland purchasers: The installation of anchorage points must be approved by authorised officers appointed by Queensland Transport. Authorised officers can be sourced from all Queensland Transport Customer Service and Queensland Ambulance Service Centres.

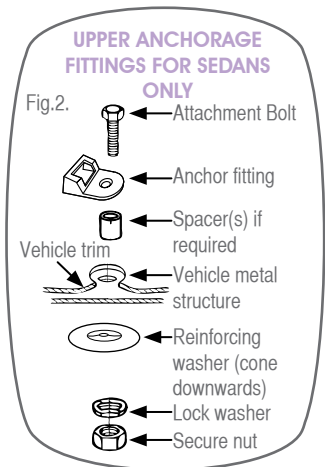

INSTALLATION OF CAR ANCHOR FITTING

ONLY USE A 5/16 UNC GRADE 5 BOLT. IF THE BOLT IS NOT THE CORRECT LENGTH THE CAR MANUFACTURER'S HAND BOOK CAN PROVIDE ADVICE ON THE CORRECT LENGTH BOLT.



WARNING

CHILD RESTRAINTS MUST NOT BE ATTACHED TO UNSOUND METAL OR TO WOOD, OR SYNTHETIC STRUCTURES. WHEN DRILLING 9mm HOLE DO NOT DRILL THROUGH FUEL LINES, FUEL TANKS, ELECTRICAL WIRING, OR RADIO SPEAKERS.

WEBBING STRAPS MUST BE PROTECTED FROM SHARP CORNERS AND EDGES. THE ANCHOR FITTING MUST BE USED ONLY AS DESCRIBED ABOVE. IT MUST NOT BE HOOKED ONTO ANY OTHER OBJECT.



Note: Marking on the top of a Grade 5 Bolt.

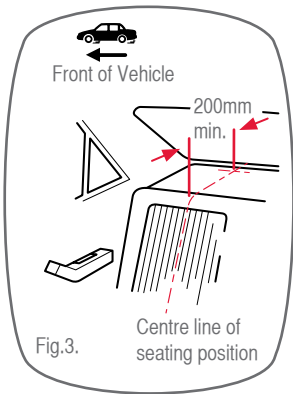



TRAVEL SYSTEM-USE WITH STROLLER

This Carrier is designed to be connected to compatible Babylove strollers. The following pages provide general instructions about using the Carrier with a stroller. This may differ slightly for some strollers. Preferably use the attachment instructions provided with your stroller. Use the stroller in accordance with the instructions supplied with the stroller.



WARNINGS

DO NOT LEAVE THE CHILD IN THE CARRIER FOR EXTENDED PERIODS.

THE CARRIER IS DESIGNED TO PROVIDE MOBILITY OUTSIDE OF THE CAR BUT IT SHOULD NOT BE USED IN PLACE OF AN APPROPRIATE COT. DO NOT LEAVE THE BABY IN THE CARRIER FOR EXTENDED PERIODS.

THE CARRIER MUST ONLY BE USED WITH A BABYLOVE STROLLER WITH COMPATIBLE ATTACHMENTS. DO NOT USE WITH ANY OTHER STROLLER.

IF IN DOUBT ABOUT THE METHOD OF INSTALLATION OR SUITABLE COMPATIBLE STROLLERS, CONTACT NURSERY ELEGANCE CUSTOMER SERVICE ON 1300 131 477.

Always ensure the baby is secured in the Carrier with the harness at all times.

TRAVEL SYSTEM-USE WITH STROLLER

FITTING THE CARRIER TO THE STROLLER

NOTE - Ensure that the child is harnessed in the Carrier according to these instructions. See pages 28 to 31.

- Engage the brakes and place the stroller backrest into the fully reclined position.
- Locate and uncover the mounting slots on the stroller armrest.
- Hold the Carrier by the carry handle, and also if you prefer, by the front rebound bar. Face the feet end of the Carrier towards the stroller backrest.
- Lower the Carrier into the exposed mounting slots. Press down firmly on both sides until you hear it click and it locks into place.

IMPORTANT:

Ensure that the Carrier is locked into place by pulling up on both sides. Do not use the Carrier if it is not correctly installed.

- Rotate the Carrier handle down if you prefer. Press both buttons and hold them in. Then rotate the handle slightly backwards and then release. Continue to rotate the handle back over the canopy. Push down until it locks.

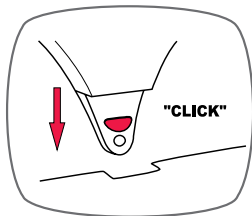
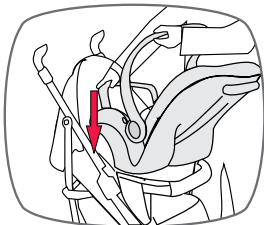

WARNING

Use the harness at all times.

TRAVEL SYSTEM-USE WITH STROLLER

REMOVING THE CARRIER FROM THE STROLLER

- A. Engage the brakes.
- B. Press both buttons on the side of the handle. Then continue to rotate the handle slightly forwards and then release. Rotate the handle up over the canopy. Check the handle is locked in the upright position.
- C. To release the Carrier from the stroller, locate the release lever on the back (head end) of the Carrier. Squeeze up and hold in to release the retaining locks. Lift the Carrier up by the handle and remove from the stroller.

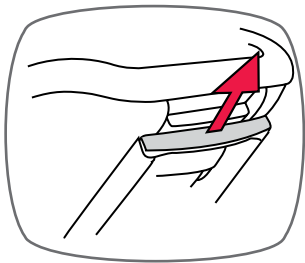
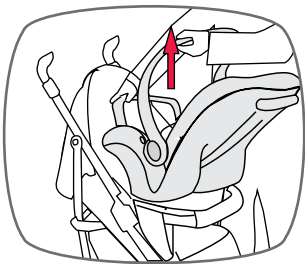



TRAVELLING TIPS

SAFETY

Never hold a baby in arms when riding in a motor vehicle. In this position the baby could be thrown against the dashboard, windscreen or other occupant and suffer serious injury or death.

When riding in a motor vehicle never nurse a baby using the same seat belt for both of you. In this position the baby or child could be crushed.

Never breast feed a baby while car is in motion.

Children must be secured in appropriate restraints at all times when the car is in motion. Children travelling unrestrained and standing up in the car are in danger of serious injury or death. Traffic regulations in all states require children to be secured in child restraints or adult seat belts where available.

Plan your trip with frequent comfort stops to reduce stress on babies, young children and driver. Keep the car well ventilated to reduce heat stress. Car windows should be kept open to maintain a good flow of fresh air.

Never leave babies or toddlers in a stationary car because of the risk of heat exhaustion.

Ensure babies and toddlers are adequately shaded from direct sunlight through side or rear windows.

Check the car is ventilated by opening windows or using the car's ventilation system taking in external air. Recirculation setting is not suitable for providing ventilation.

Be on guard against carbon monoxide poisoning which can occur through only a slight leak in the exhaust system while travelling in a closed car.

Securely stow all heavy objects, feeding bottles, etc. that could become missiles during an accident and/or cause injury to another occupant.

CLOTHING/BATHING

Since it is often warmer in the car, dress the baby in light clothing.

Do not harness an infant wrapped in a blanket or swaddled. Any blanket or wrap must only be placed over the harness and infant.

IN CASE OF ACCIDENT

IN CASE OF ACCIDENT

If your restraint has been involved in a severe crash, you should destroy the restraint even if no damage is obvious. Some insurance companies offer vehicle insurance which covers or partially covers the replacement of your child restraint. Contact your insurance company for further details.

Your insurance company may require you to keep the child restraint for assessment, **but do not use the child restraint after a severe crash.**

45



AUSTRALIA

Phone number: 1300 131 477

NEW ZEALAND

Phone number: 0508 688 822

www.babylove.com.au

We reserve the right to alter this product without notice in our constant endeavour for improvement.
Nursery Elegance Pty. Ltd. Trademarks of Babylove and devices are owned by Nursery Elegance Pty. Ltd.
This product is covered by Australian patent application.
© 2007 - 2015

baby 
loveTM

P/No. 2202461/A