

INSTRUCTION BOOK

EXPANDABLE BOOSTER SEAT

Series No. BL4200A/2010

 **IMPORTANT:**
**KEEP THIS BOOKLET IN THE PLACE PROVIDED
ON THE CHILD RESTRAINT**

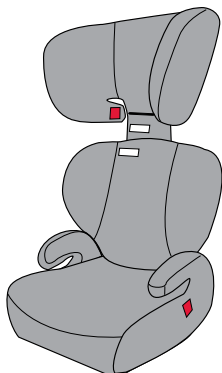

To be used with either a lap-sash seat belt or an add-on accessory child harness by children whose shoulders are above the lower shoulder height marker with head restraint in lowest position (approximately 4 years of age) until child's shoulders reach the upper shoulder height marker with head restraint in highest position (approximately 6 to 8 years of age).

Suitable for use only with the EzyGo Harness™ Series BL220/2010 and Safe-n-Sound™ Protecta PLUS™ Child Harness Series 220/2010.



INDEX

PAGE

- 3** INTRODUCTION AND IMPORTANT INFORMATION
- 4** WARNINGS
- 6** SHOULDER HEIGHT MARKERS AND A GROWING CHILD
- 8** FEATURES
- 10** SUITABLE FOR USE
- 11** HOW TO SETUP
- 12** HOW TO INSTALL
- 14** HOW TO USE - WITH SEAT BELT
- 17** HOW TO USE - WITH CHILD HARNESS
- 29** THE NEXT RESTRAINT
- 30** CARE AND MAINTENANCE
- 32** ACCESSORIES
- 33** INSTALLATION OF CAR ANCHOR FITTING
- 37** PRECAUTIONS
- 38** IN CASE OF ACCIDENT

INTRODUCTION & IMPORTANT INFORMATION

This Booster Seat is designed for use by children from approximately 4 years of age up to approximately 6 to 8 years of age in vehicles using a lap-sash seat belt or with a seat belt and Child Harness. The Booster Seat must not be used with just a lap only seat belt as the upper body of the child is not protected. It must be used with a lap-sash seatbelt.

This Booster Seat is fitted with the **VERSATETHER™** catch that allows it to be used with compatible Child Harnesses. The Booster Seat and Child Harness can be used with either a lap or lap-sash seatbelt.

Only the Babylove EzyGo Harness™ Series BL220/2010 or Safe-n-Sound™ Protecta PLUS™ Child Harness Series 220/2010 Child Harness are suitable for use with this product. No other Harness is suitable with this Booster Seat.

A child that is not tall enough to reach the upper shoulder height marker in their seat with in-built harness will be too small for this Booster Seat. This Booster Seat should be used until the child no longer fits in the seat or the child can sit in the car's seat with their lower leg able to hang over the seat cushion.

This Booster Seat is not designed to be reclined.

CAREFULLY READ ALL THE INSTRUCTIONS FOR INSTALLATION.

IN THE EVENT OF DOUBT ABOUT THE METHOD OF INSTALLATION, CONSULT BABYLOVE OR A CHILD RESTRAINT FITTING STATION AUTHORIZED BY A RELEVANT TRANSPORT AUTHORITY. IN NEW ZEALAND, CONTACT THE AGENT FOR THE VEHICLE.

THIS RESTRAINT MUST BE USED IN CARS WITH FORWARD FACING SEATS WITH A LAP-SASH SEAT BELT OR WITH A SEAT BELT AND CHILD HARNESS.

No child restraint can guarantee absolute protection from injury in every crash. However, to ensure that your child gets all the protection designed into the restraint **PLEASE READ AND FOLLOW THESE INSTRUCTIONS EXACTLY.**

Always store the instruction book in the pocket attached to the back of the cover, for future reference.



WARNINGS

- Use the restraint exactly as shown in the instructions.
- Supervision of children is needed because they may be able to undo buckles and adjusters.
- **DO NOT LEAVE CHILDREN UNATTENDED IN THE CAR.**
- Do not alter or modify this restraint, use only recommended parts and accessories.
- Repairs must only be done by the manufacturer or agent.
- Do not allow the restraint to come into contact with polishes, oils, bleach and other chemicals.
- Destroy the restraint if it has been in a severe crash, even if no damage is visible.
- **DO NOT USE WITH JUST A LAP BELT.** You must use with lap-sash seat belt, or with a seat belt and Child Harness.
- The lap part of the seat belt must be firmly across the thighs and sash straps fitted diagonally across the chest and on the shoulder.
- If used with a Child Harness, the lap strap of the seatbelt must be adjusted firmly first, and then the harness, so that the lap-strap is not lifted off the child's lap when the harness is adjusted.
- **DO NOT USE THIS RESTRAINT WITHOUT THE COVER.**
- **IF AN AIRBAG IS FITTED IN THE SEATING POSITION WHERE THE CHILD RESTRAINT IS TO BE FITTED, FOLLOW THE VEHICLE MANUFACTURER'S WARNINGS AND INSTRUCTIONS.**
- Regularly check the restraint components, straps and other fitments for correct function, cracking & condition. Seek prompt repair.



WARNINGS

- Straps may be damaged by unsecured cargo in a collision. Secure or remove hazardous cargo before using this strap. Hatch-back or wagon: Do not use the child restraint where this strap may fall into a split in the seat back. Always attach hook and remove slack.
- Securely stow all heavy objects, feeding bottles, cup holders, etc that could become missiles during an accident and cause injury to any occupant.
- The restraint should not be purchased or sold as a second hand item. It is recommended not to use child restraints older than 10 years as the protection in an accident may be reduced.
- THIS RESTRAINT MUST BE ATTACHED TO A CHILD RESTRAINT ANCHORAGE POINT IN THE CAR. REFER TO CAR OWNER'S HANDBOOK FOR LOCATION OF ANCHORAGE POINTS. REFER TO A CHILD RESTRAINT FITTING STATION IF NO ANCHORAGE POINTS ARE IN THE MOTOR CAR.
- THIS RESTRAINT IS NOT SUITABLE FOR USE WHERE THE ANCHORAGE STRAP MAY FALL INTO A SPLIT IN THE SEAT BACK. (E.G. HATCHBACK OR WAGON).
- Do not store in areas that may get hot, like in car boots, roof space, beside shed walls which get hot in summer. Do not place heavy items on top of the seat as this may distort the plastic



WARNING:

DO NOT LEAVE CHILDREN UNATTENDED IN THE CAR.

SHOULDER HEIGHT MARKERS & A GROWING CHILD

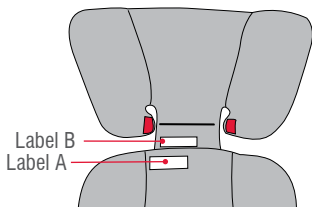

Height label maybe behind the child's back.

SMALLER CHILD

Shoulders must not be below the Lower Shoulder Height Marker (label A) when the headrest is the lowest position.

From approximately 4 years of age.

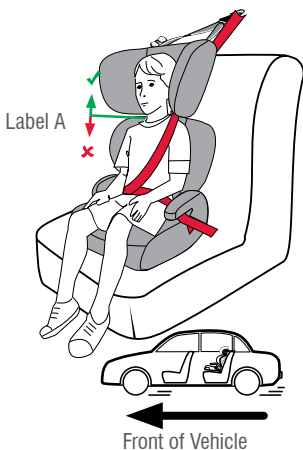

TALLER CHILD

Shoulders must not be above the Upper Shoulder Height Marker (label B) when the headrest is in the highest position.

To approximately 6 to 8 years of age.

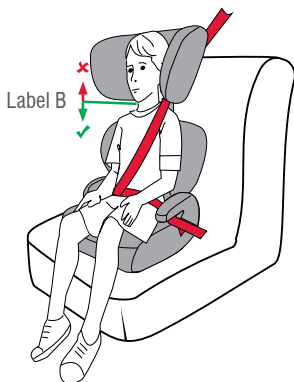

NOTE: These heights also apply if you are using a Child Harness with this Booster Seat.

SHOULDER HEIGHT MARKERS & A GROWING CHILD

 **IMPORTANT:** Follow this advice.

Label A Smaller Child - Lower Shoulder Height Marker

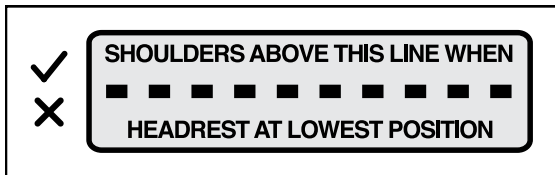

A Child who has outgrown their child restraint with in-built harness will have their shoulders in line or above the lowest shoulder height marker (label A) of this booster seat with the headrest in the lowest position. If the child's shoulders are below this marker the child needs to stay in their child restraint with an in-built harness.

Label B Larger Child - Upper Shoulder Height Marker

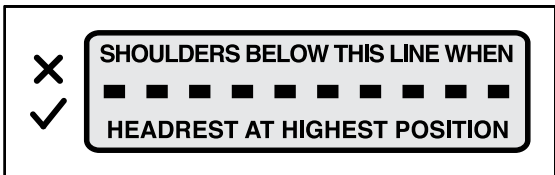

The seat can be used until the child's shoulders reaches the top marker (label B) with the headrest fully raised. Usually the shoulder will contact the bottom of the headrest, it is then time to move to the next form of restraint. For maximum safety continue to use this seat as long as the child fits in it.

Once the child no longer fits, move to the next form of child restraint, see page 29.

FEATURES

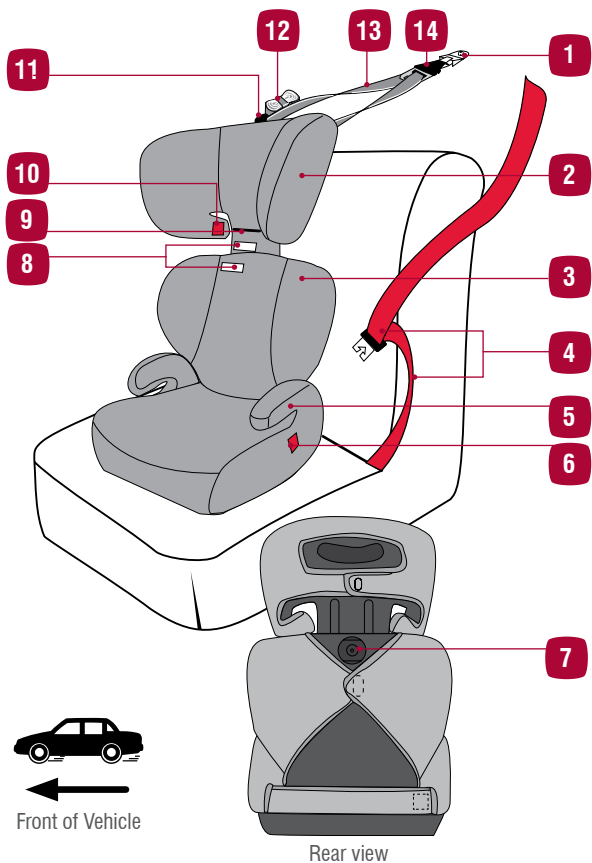

- 1** Car's Anchor Fitting
- 2** Adjustable Height Headrest
- 3** Padded Cover for Comfort
- 4** Car Seat Belt
- 5** Armrest (on each side)
- 6** Booster Belt Path Label (each side)
- 7** Headrest Adjustment Knob
- 8** Shoulder Height Markers
- 9** Shoulder strap slot for use with Child Harness
- 10** Seatbelt path label & Sash Guide (each side of headrest)
- 11** Upper Anchorage Strap Adjuster
- 12** Upper Anchorage Storage Band
- 13** Adjustable Upper Anchorage Strap
- 14** Attachment Clip with VERSATETHER™ Catch

SUITABLE FOR USE

To be used with either a lap-sash seatbelt or an add-on accessory Child Harness by children whose shoulders are above the lower shoulder height marker with the head restraint in the lowest position (approximately 4 years of age) until their shoulders reach the upper shoulder height marker with the head restraint in the highest position (approximately 6 to 8 years of age). Continue to use this child restraint until child reaches the limit. Children are safest in a Booster Seat until their shoulders reach the upper shoulder height marker of the Booster Seat.

Do not use this restraint until child's shoulders are above the lower shoulder height marker with the head restraint in the lowest position.

Just using a seatbelt is not recommended for children that have outgrown this seat. Use a larger Booster Seat.

THIS RESTRAINT MUST BE USED IN CARS WITH FORWARD-FACING SEATS WITH A LAP-SASH SEAT BELT OR WITH A SEAT BELT AND CHILD HARNESS.



WARNING

- If your vehicle is not fitted with an anchor point, please contact a Safety Restraint Fitting Station authorised by the relevant State Government Body for correct fitment of the restraint. In New Zealand contact the agent for the vehicle. The upper anchorage strap must be attached to an anchorage point using an extension strap if necessary.
- **DO NOT USE WITH JUST A LAP BELT.** You must use with lap-sash seat belt, or with a seat belt and Child Harness.
- Do not use the restraint without the Upper Anchorage Strap attached.
- Do not use in a front seat, unless it has a child restraint anchorage point and your child is over 4 years of age or in accordance with the applicable Road Rules in your region.
- Do not use on any vehicle seat which faces sideways or rearwards.
- To ensure all safety information is provided, only use replacement covers for this Booster Seat supplied by Babylove™.

ADJUSTING THE HEADREST

The headrest can be adjusted to lock into different height locations. Remove the child from the seat to adjust the headrest. If stiff you may need to remove the seat from the vehicle to adjust the headrest.

Pull out the knob located on the back of the restraint, while lifting up the headrest with the other hand, pull or push the headrest higher or lower until it is at the desired position for your child.

Check that the headrest is locked into position by gently pushing down on it.

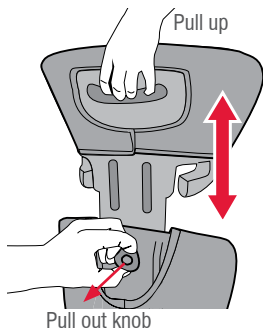

Pull up or push down on the headrest to position the bottom of the sash guide level with or just above your child's shoulder. (But not more than 30mm above)

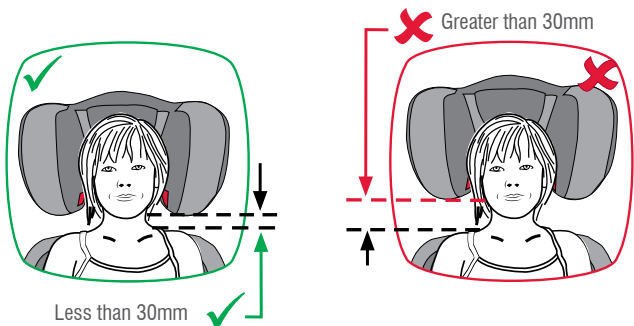

The headrest position will need to be checked with the child sitting in the seat. If not correct then adjust to the next position and recheck the fit on the child. This adjustment will need to be repeated as the child grows.

NOTE: Where a child Harness is fitted, you may need to adjust the shoulder strap length.

HOW TO INSTALL

INSTALLING INTO VEHICLE

Locate the child restraint anchorage fitting in the car that is directly behind seat location in the rear seats. Refer to the car Owners Manual. If there is no anchorage fitting then refer to pages 33 and 36 for assistance in adding an anchor fitting.

Adjust the headrest to the correct height for your child (refer to page 11).

Position the Booster Seat in the car facing forward in the chosen seating position.

Lengthen the upper anchorage strap by pressing the adjuster button (1) and pulling the strap (2). Hook the attachment clip of the Upper anchorage Strap to the anchor fitting in the vehicle. Make sure to remove multiple twists from the upper anchorage strap. **THIS UPPER ANCHORAGE STRAP MUST ALWAYS BE FITTED WHEN THE CHILD RESTRAINT IS USED IN A VEHICLE.**

Pull the Upper Anchorage Adjuster Strap (3) to just remove slack. Do not tighten causing the Booster Seat base to lift off the vehicle seat.



Attachment Clip

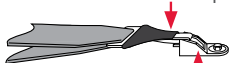

Car's Anchor Fitting

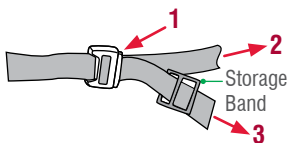

Storage Band

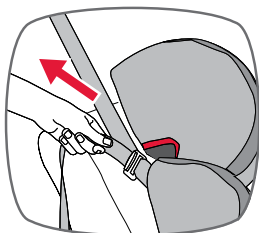

Pull to remove slack



WARNING

Always attach hook and remove slack.

HOW TO INSTALL

ALWAYS roll up excess strap tightly and use storage band to neatly store away from child's reach.

NOTE: In some car's, the car's headrest may need to be raised or even removed to allow the Booster Seat to sit correctly, the vehicle headrest may also interfere with the routing of the upper anchorage strap. If removed, store the vehicle headrest in a safe place but **ALWAYS refit once the Booster Seat is no longer used.**

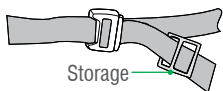

Storage
Band

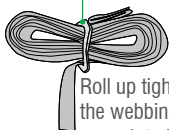

Roll up tightly so the webbing is thick enough to be held in the storage band.

HOW TO USE

USE WITH SEATBELT

USING LAP-SASH SEAT BELT (WITHOUT Child HARNESS)

With the Booster Seat fitted to the vehicle as described on the previous page, push backrest to touch the car's seat back and ensure the upper anchorage strap is connected.

Sit your child on the seat. Ensure the headrest is set to the correct height for your child. (See page 11).

Position the lap-sash belt over the child ensuring the lap portion is positioned over the thighs of the child and ensure the lap and sash are under the armrests following the red seat belt path labels marked:

BOOSTER SEATBELT PATH

Fit the sash portion of the belt across the child's chest and through the sash guide (red BOOSTER SEATBELT PATH label) on the headrest as shown.

! IMPORTANT:
ALWAYS USE THIS SASH GUIDE.

Engage seat belt buckle and tongue ensuring there are no twists in the belt. If the seat belt buckle is adjustable, adjust the buckle as low as possible away from the child.

Red **BOOSTER SEATBELT PATH** Label

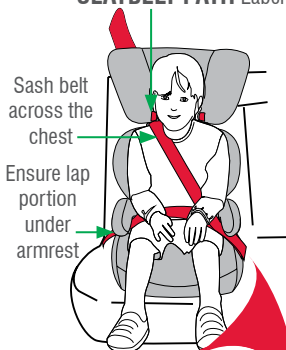

Ensure both lap and sash belts are under the armrest on buckle side

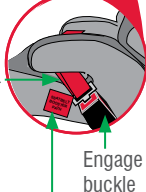

Red **BOOSTER SEATBELT PATH** Label

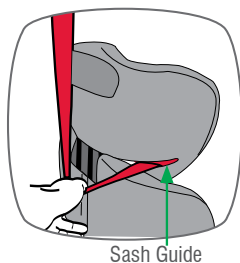

HOW TO USE

USE WITH SEATBELT

Adjust lap and sash portion of seat belt firmly but comfortably across the child's lap and chest.

If using the Inertia Reel Retractor seat belt, adjust the lap portion of the seat belt firmly around the child and Booster Seat, then let the slack sash portion retract up into the sash retractor.



IMPORTANT:

Always ensure the seat belt is correctly restraining the child on the Booster Seat. The sash must NEVER be under the arm or behind the back of the child. The lap belt must ALWAYS be firmly on the child's thighs and not on their abdomen.

The child should always sit upright and not slump so that the lap belt is across the top of the thighs.



WARNING:

DO NOT LEAVE CHILDREN UNATTENDED IN THE CAR.

TO REMOVE CHILD

Disengage seat belt tongue and buckle. Remove belt from child. When Booster Seat is not being used, secure in position, by engaging seat belt over the Booster Seat or store in a safe place.

IMPORTANT:

Use seat belt to hold the child restraint when not in use.

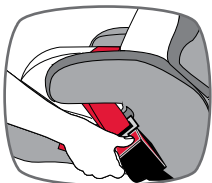

HOW TO USE

USE WITH SEATBELT

! WARNING : A sash belt under the arm or behind the back is dangerous.

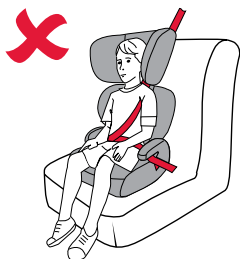

SEAT BELT UNDER THE ARM IS DANGEROUS

SEAT BELT BEHIND THE BACK IS DANGEROUS

Sash-belt through the sash guide.

Lap belt must always be firm on the thighs. The child must not slump or slouch.

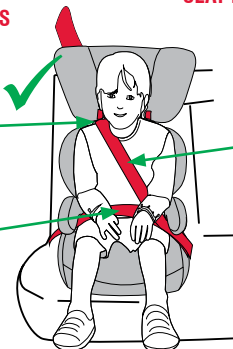

Headrest adjusted so it is close to the shoulders. Seat belt across the chest.

! IMPORTANT:

Always ensure that the seat belt is fitted firmly to the child's hips and thighs and the sash belt is diagonally across the chest.

NOTE: Seat belt extenders should not be used if the seat belt is not long enough to fit around the child. If a seat belt extender is used then the seat belt buckle must not be in contact with the child.

USING WITH A CHILD HARNESS

This Booster Seat is only suitable for use with Babylove EzyGo Harness™ Series BL220/2010 or Safe-n-Sound™ Protecta PLUS™ Harness Series 220/2010. Refer to the instruction book supplied with the Child Harness for full details of using and installing the Child Harness. When installing the Child Harness into the vehicle and Booster Seat, connect the upper anchorage strap to the **VERSATETHER™** Catch on the Booster Seat's upper tether strap (as shown below).

If required, use the extension strap supplied with the child harness for all other instances to attach the harness to anchor points in the luggage area such as the vehicle floor or ceiling. Not suitable for most other styles of child safety harnesses.

INSTALLING BABYLOVE EzyGO HARNESS™ INTO VEHICLE WITHOUT EXTENSION STRAP

Hook the Child Harness attachment clip (1) onto **VERSATETHER™** Catch (2). Then hook attachment clip (3) onto anchor fitting. Ensure that none of the straps are twisted and not passing over any sharp edges.

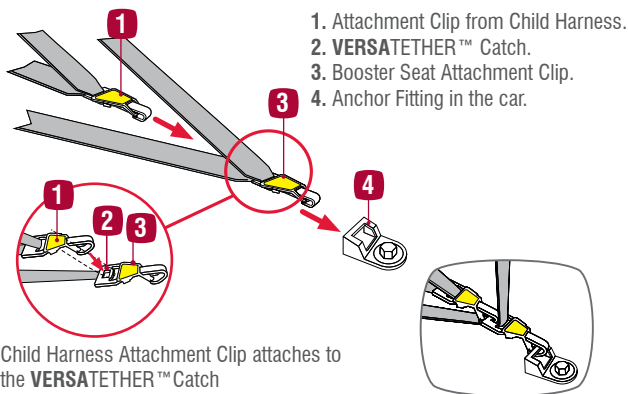

Child Harness Attachment Clip attaches to the **VERSATETHER™** Catch

NOTE:

Do not use the **VERSATETHER™** catch on the Child Harness Clip (1). **VERSATETHER™** catch (2) is only for use with a Child Harness.

HOW TO USE

USE WITH CHILD HARNESS

INSTALLING BABYLOVE EzyGO HARNESS™ WITH EXTENSION STRAP INTO VEHICLE

An adjustable extension strap is supplied with the Child Harness. Hook the EzyGo Harness™ clip first onto the extension strap catch, then hook the extension strap hook onto the **VERSATETHER™** Catch on the Booster Seat's upper anchorage strap as shown below. Ensure that none of the straps are twisted or catching on sharp edges. Tighten the Booster Seat's upper anchorage strap (refer to page 12) then remove excess slack from the extension strap by pulling the adjuster strap as illustrated below.

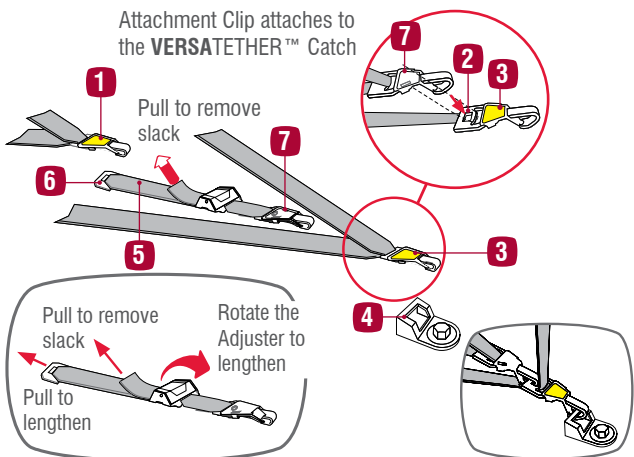

To lengthen the Adjustable Extension strap rotate the adjuster and pull the main strap.

1. Attachment clip from the Child Harness
2. **VERSATETHER™** Catch
3. Booster Seat Attachment Clip
4. Anchor Fitting in the Car
5. Adjustable Extension Strap
6. Extension Strap Catch
7. Extension Strap Attachment Clip

CHOOSING METHOD OF INSTALLATION

The Harness can be installed using either of the following methods.

Method 1 - Using a lap-sash seat belt in conjunction with Gated Slide (provided with Child Harness) to convert to a lap belt.

Method 2 - Using lap seat belt.

Before installing the Harness determine which method of installation is required and follow instructions carefully.

REFER TO THE CHILD HARNESS INSTRUCTIONS FOR FULL DETAILS ON HOW TO USE AND INSTALL THE CHILD HARNESS

INSTALLING THE HARNESS

Decide which seating position you are going to use and which seat belt type is installed in that position. If using a lap-sash seat belt then a Gated Slide must be used.

A. Ensure the headrest is set to the correct height for your child (See page 11).

B. Hook the attachment clip to the anchor fitting and tighten (refer page 12). Make sure to remove any twists from the upper anchorage strap. **THIS UPPER ANCHORAGE STRAP MUST ALWAYS BE FITTED WHEN THE CHILD RESTRAINT IS USED IN A VEHICLE.**

Hook attachment clip to the anchor fitting in the Car. ↓



HOW TO USE

USE WITH CHILD HARNESS

C. Lengthen the Child Harness using the adjuster under the cover (see the Child Harness instructions on the adjustment method). Press the Adjuster button (1) on the adjuster and pull the shoulder strap (2)

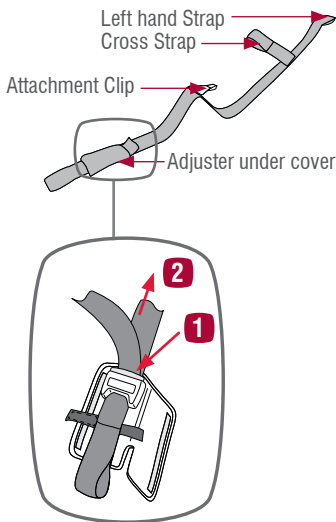

D. Feed the left hand harness strap and attachment clip through the shoulder strap slot of the Booster Seat cover.

Pass the left hand Strap and Attachment Clip through the shoulder strap slot

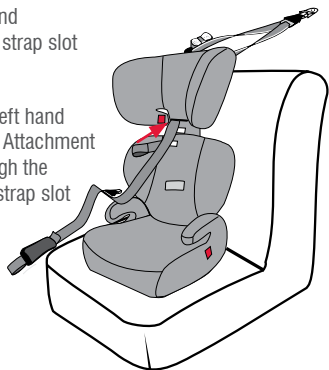

HOW TO USE

USE WITH CHILD HARNESS

Hook the Attachment Clip onto **VERSATETHER™** Catch

E. Then feed the left hand harness strap back through the shoulder strap slot in the Booster Seat cover, on the opposite side of the headrest neck keeping the attachment clip at the back of the Booster Seat.

Feed left hand Child Harness Strap & Cross Strap through shoulder strap slot of Booster Seat cover.

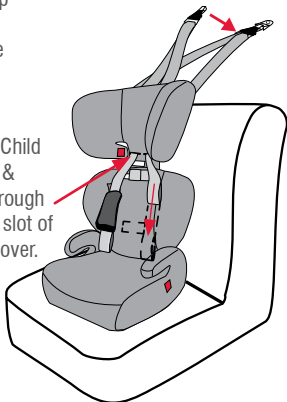

The harness shoulder strap will now be around the neck of the headrest.

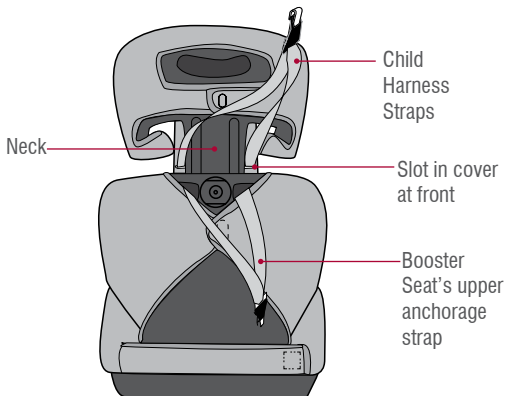

Rear view of Booster Seat showing harness straps feeding through the headrest cover slot and on each side of the headrest neck

HOW TO USE

USE WITH CHILD HARNESS

F. Hook the harness Attachment Clip onto the **VERSATETHER™** Catch.

Ensure shoulder straps are of equal length.

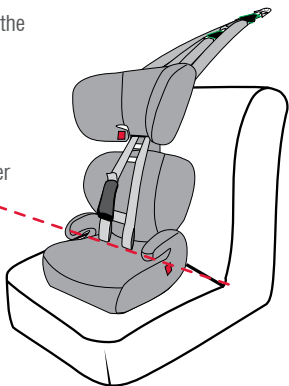

NOTE: The shoulder straps must be in the slots which are nearest to the child's shoulder's but not lower than the child's shoulders. As there are only one slot position in the cover the shoulder strap slots will be correctly positioned provided the headrest is set to the correct height for your child (refer to page 11).

USING LAP-SASH SEAT BELT WITH CHILD SAFETY HARNESS.

(Using Gated Slide provided with Child Harness.)

Refer to the Harness instructions for fitting the gated slide to the lap-sash seat belt. Once fitted, position the gated slide near to the child (under the armrest) but not touching the child. Thread the converted lap-sash seat belt through the harness strap loops as shown left. Ensure there are no twists in the harness, cross strap and seat belt.

IMPORTANT NOTE: Some vehicle seat belts are too short and you may experience some difficulty fitting the converted lap-sash around your child. If so, adjust the gated slide nearer to your child, (ensure the slide does not touch your child). This may provide more belt length to fit your child, but if the belt still will not fit, try another location in the vehicle, e.g.. side seat. If the vehicle seatbelts are still too short, then contact the vehicle manufacturer for advice on longer seat belts.

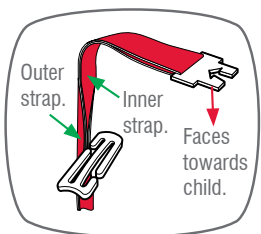

Position the Gated Slide under the armrest but not touching the child.

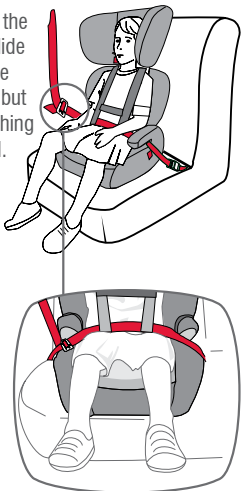

HOW TO USE

USE WITH CHILD HARNESS

FITTING THE GATED SLIDE TO THE LAP-SASH SEAT BELT

A. Hold the lap and sash straps together and fold as shown right. Slide the inner strap into the Gated Slide followed by the outer strap.

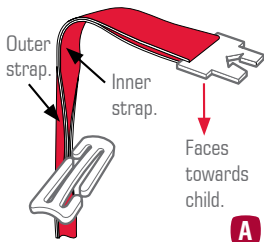

B. The two straps should slide freely in the Gated Slide slot.

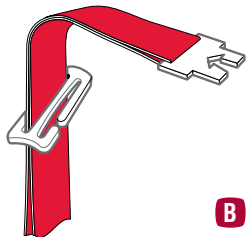

C. Repeat previous step **A** for the other slot in the Gated Slide.

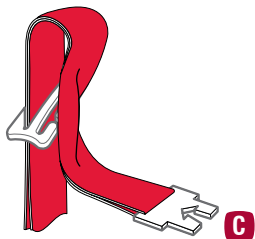

USE WITH CHILD HARNESS

D. Feed the straps through the Gated Slide to remove any slack.

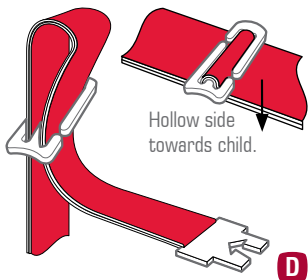

E. There may be two types of Gated Slides available, Curved and Flat.

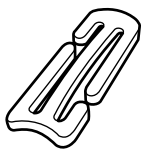

Curved

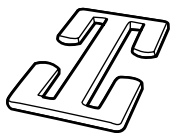

Flat

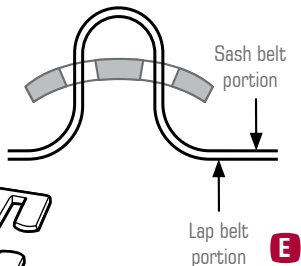

When fitting the Curved Gated Slide, the seat belt route can only go one way, as shown right.

HOW TO USE

USE WITH CHILD HARNESS

METHOD 2: USING LAP SEAT BELT WITH CHILD HARNESS.

Adjust the headrest to align with the top shoulder slots of the restraint. Fit the Child Harness as shown above. Then connect the cross strap as shown below. Thread the lap seat belt through the harness strap loops as shown right.

NOTE: Seat belt extenders should not be used if the seat belt is not long enough to fit around the child. If a seat belt extender is used then the seat belt buckle must not be in contact with the child.

Connect the Child Harness to the **VERSATETHER™** Catch as detailed on page 17 or 18.

A. With the child seated, place each of the harness straps over each shoulder.

B. Feed the Right hand strap (loop end) into the cross strap loop to connect the two sides.

C. Feed the adult belt (lap belt or converted lap/sash) through the harness loops, ensuring that the cross strap loop does not disconnect. Also ensure there are no twists in the harness, cross strap and seat belt

1. Left Hand Harness Strap
2. Right Hand Harness Strap
3. Storage strap
4. Cover Pad
5. Right Hand Harness Strap Loop
6. Cross Strap Loop
7. Cross Strap
8. Booster Seat Upper Anchorage Strap
9. Car's Anchor Fitting

Harness strap loops

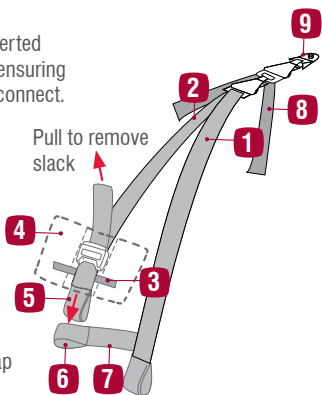
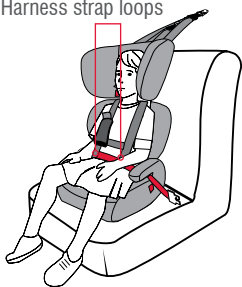

HOW TO USE

USE WITH CHILD HARNESS

D. Engage the seat belt tongue to the buckle and adjust the seat belt to sit firmly but comfortably around the child's pelvis. The seat belt buckle should be located as low as possible below the child's hip.

E. With the lap belt (or converted lap/sash) adjusted to be a firm fit on the child's thighs, then adjust the Child Harness to remove all slack in the shoulder straps. Once adjusted, further adjustments are necessary only to the upper extension straps and to accommodate the growth of the child.

F. Finally, roll up the free end of the harness's adjuster strap, secure using the storage strap, then place it into the top of the adjuster and close the cover pad.

G. To lengthen the harness at any time, fully press the Adjuster Button (1) whilst pulling the shoulder strap (2) upwards.



Fold the adjuster strap and secure with Storage strap.

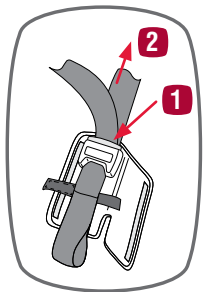
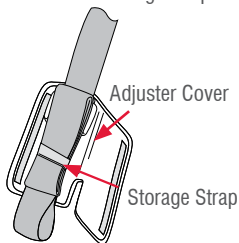

HOW TO USE

USE WITH CHILD HARNESS

IMPORTANT:

If used with a Child Harness, the lap strap of the seat belt must be adjusted firmly first, and then the harness, so that the lap-strap is not lifted off the child's lap when the harness is adjusted.

Remove slack in the Harness shoulder straps as shown on the previous page.

TO REMOVE CHILD

Disengage seat belt tongue and buckle and remove harness and belt from child. When Booster Seat is not being used, secure in position, by engaging seat belt over the Booster Seat or store in a safe place.

NOTE: It maybe easier to unthread the car seat belt out of the loops before lifting the harness over the child's head.

Once the child is too large for the Booster Seat , the Child Harness can still be used and is a significant safety device for children in a lap only seat belt. Refer to the Child Harness instruction book.

IMPORTANT:

Use seat belt to hold the child restraint when not in use.

WARNING:

DO NOT LEAVE CHILDREN UNATTENDED IN THE CAR.

IMPORTANT:

The Gated Slide must be removed from the seat belt if the Booster Seat and Child Harness are no longer used in the car to allow other users to use the seatbelt as a lap-sash seatbelt.

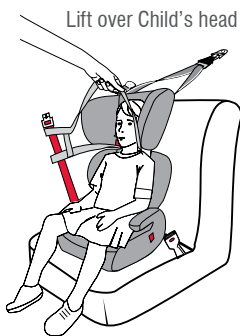

THE NEXT RESTRAINT

Next type of restraint that can be used in the car for your child.

When your child has outgrown the seat, you can then either use:

Just the car's lap-sash seatbelt.



Or you can use a Child Harness and lap seat belt. Lap seat belts can be dangerous without a Child Harness.



Or you can use a narrow Booster Seat suitable for children up to 8-10 years of age. An accessory Child Harness may be used.



CARE & MAINTENANCE

REGULAR CARE OF THIS RESTRAINT:

Please check the following items regularly to ensure the safety of your child:

- A. Check the webbing for fraying.
- B. Ensure there are no cracks in moulding or the plastic moulding.
- C. If any part of the restraint is cracked or broken, seek repair immediately or replace the child restraint.
- D. Clean the cover and the seat regularly.

HOW TO CLEAN

Use only mild soap and water with a moist cloth to clean all metal and plastic parts of the Booster Seat.

Do not use harsh cleaners, polishes, oils, bleach or other chemicals.

COVER

The Booster Seat has a cover made from flame retardant fabric and is removable for cleaning. Washing and care instructions are on the care label attached to the cover. Refer to the following pages for instructions on how to remove and replace the cover.

Connect the hook and loop parts so that the cover is not damaged in the wash.



VERY IMPORTANT:

Only use this child restraint with the cover supplied or a manufacturer-authorized replacement cover with identical shoulder height markers.

CARE AND MAINTENANCE

TO REMOVE COVER

Follow the sequence below A to F. to remove the cover.

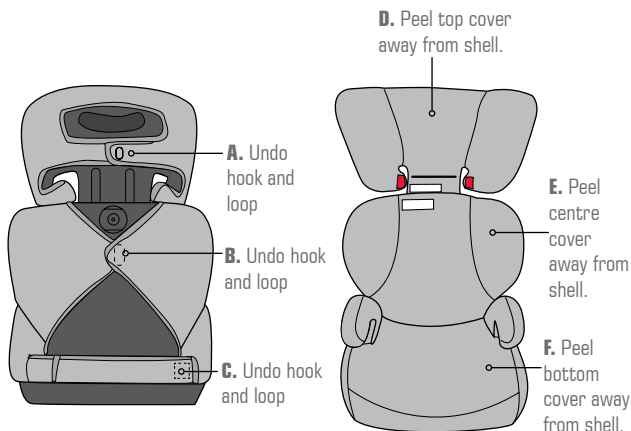

TO REPLACE COVER

1. Fit bottom cover on base and re-attach hook and loop (C).
2. Align and fit top cover over headrest and headrest impact pad and re-attach hook and loop (A).
3. Align and fit center cover over backrest.
4. Re-attach hook and loop (B).
5. You will need to fit the Booster Seat back in the car and attach the upper anchorage strap. Adjust the headrest.

ACCESSORIES

HEADREST INSERT (if fitted)

The headrest insert is designed to provide additional comfort for the child. Fit the padded headrest insert between headrest cover. Discontinue use of the headrest insert if it causes discomfort.

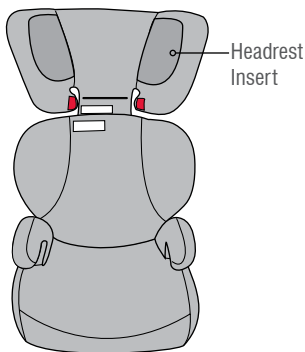

VEHICLE INSTALLATION ACCESSORIES

(Available from retailers of Babylove products)

EXTRA ANCHOR KITS: Are available if using the restraint in additional vehicles.

Re-order number: K402/a

EXTENSION STRAPS: May be required for vehicles without a fixed parcel shelf.

Re-order number: K304 (length 300mm)
or K305 (length 600mm).

INSTALLATION OF CAR ANCHOR FITTING

Consult the vehicle owner's handbook for location of anchorage fittings or anchorage points and the possible use of spacers. Some vehicles may have an anchor fitting fitted by the vehicle manufacturer. If anchorage points cannot be found refer to car manufacturer or local child restraint fitting station or traffic authority for optimum position of anchorage point and the use of spacers.



IMPORTANT WARNING:

THE ATTACHMENT CLIP COVER MUST ALWAYS BE USED AS IT PREVENTS THE RISK OF INCORRECT FITMENT OF THE ATTACHMENT CLIP TO THE ANCHOR FITTING. ALWAYS ENSURE THAT THE ATTACHMENT CLIP IS CORRECTLY ENGAGED TO THE ANCHOR FITTING AND NOT HOOKED OR FITTED TO ANY OTHER OBJECT BEFORE EACH USE OF THE RESTRAINT. THIS IS ESPECIALLY IMPORTANT IN VEHICLES SUCH AS STATION WAGONS, VANS, HATCH BACKS OR VEHICLES WITHOUT A FIXED PARCEL SHELF, SINCE THE ANCHOR POINT IS USUALLY NOT VISIBLE.

IMPORTANT INSTALLATION NOTE:

In some vehicles the anchor fitting in the rear vertical panel can only be installed in one way. Please refer to vehicle owner's handbook or a child restraint fitting station for correct method.

INSTALLATION OF CAR ANCHOR FITTING



Front of Vehicle

Extension Strap distance to be measured.
Length 300mm (Use Babylove part K304 or equivalent)
Length 600mm (Use Babylove part K305 or equivalent)
Available from retailers of Babylove products.

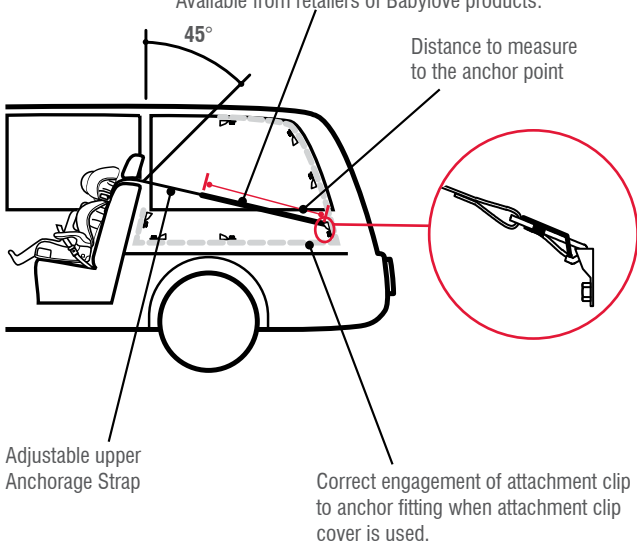

The shaded areas of this diagram illustrate the possible locations of the anchor fitting. Within each shaded area is an anchor fitting showing the correct way to install the fitting. Ensure the anchor fitting is aligned as illustrated unless stated otherwise in the vehicle Owners handbook.

INSTALLATION OF CAR ANCHOR FITTING

IF THE CAR IS FITTED WITH CHILD RESTRAINT ANCHORAGE POINT

Locate the anchorage point behind the rear seating position. (consult the car owners handbook for the location of the anchorage point). The anchorage point should be directly behind and central to the restraint. Remove thread plug from the parcel shelf/floor/roof, etc. and install attachment bolt and fitting as shown in Fig.1.

CAUTION: DO NOT OVERTIGHTEN ATTACHMENT BOLT.

OVERTIGHTENING MAY FRACTURE OR BREAK BOLT. MAXIMUM TORQUE IS 20 Nm (14.75 ft.lb.)

Note: Minimum of five full turns of attachment bolt is required before tightening force is applied.

IF THE CAR IS NOT FITTED WITH CHILD RESTRAINT ANCHORAGE POINTS

For Sedans only - Drill 9mm diameter hole in the parcel shelf on the centre line of the seating position as shown in Fig.3. Before drilling the hole, check the underside for accessibility. Install the anchor bolt as shown in Fig.2.

For vehicles other than Sedans - In Australia, consult your nearest child restraint fitting station or traffic authority for vehicle inspection to find the best, correct position for the placement of the anchorage point, and for the correct attachment bolt length and use of spacers. In New Zealand, consult the agent for the vehicle.

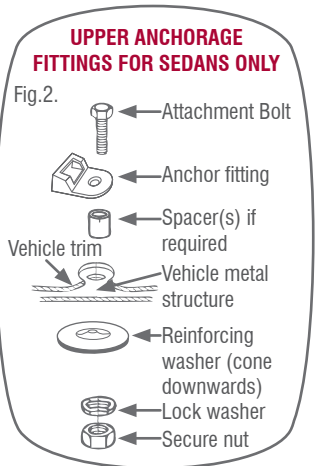
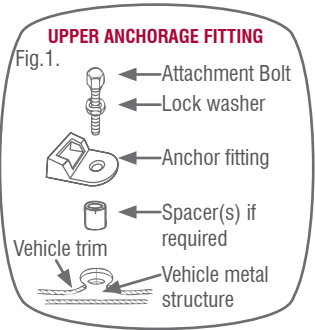

INSTALLATION OF CAR ANCHOR FITTING

Note to Queensland purchasers: The installation of anchorage points must be approved by authorised officers appointed by Queensland Transport. Authorised officers can be sourced from all Queensland Transport Customer Service and Queensland Ambulance Service Centres.

ONLY USE A 5/16 UNC GRADE 5 BOLT. IF THE BOLT IS NOT THE CORRECT LENGTH THE CAR MANUFACTURER'S HAND BOOK CAN PROVIDE ADVICE ON THE CORRECT LENGTH BOLT.



Note: Marking on the top of a Grade 5 Bolt.



WARNING

CHILD RESTRAINTS MUST NOT BE ATTACHED TO UNSOUND METAL OR TO WOOD, OR SYNTHETIC STRUCTURES. WHEN DRILLING 9 MM HOLE DO NOT DRILL THROUGH FUEL LINES, FUEL TANKS, ELECTRICAL WIRING, OR RADIO SPEAKERS.

WEBBING STRAPS MUST BE PROTECTED FROM SHARP CORNERS AND EDGES. THE ANCHOR FITTING MUST BE USED ONLY AS DESCRIBED ABOVE. IT MUST NOT BE HOOKED ONTO ANY OTHER OBJECT.

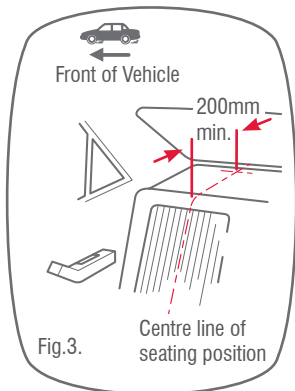

Fig.3.



Precautions to prevent reducing the safety offered by this Booster Seat.

1. Ensure the seatbelt is used and fitted correctly. The lap belt must be on thighs and not the abdomen and the sash belt must always be across the chest.
2. Always thread the sash belt through sash guide.
3. Do not cause the seat to be reclined in any way.
4. Ensure the child does not slouch or slump where the sash belt is across the abdomen. This is dangerous.
5. Do not place the seatbelt behind the back or under the arm. It is dangerous.
6. Do not use the seat belt in any other way other than following the red BOOSTER SEATBELT PATH seat belt path labels.
7. Ensure that if you are using a child safety harness that the lap belt is firm on the child's thighs and not on the abdomen. Do not tighten the Child Harness tether strap, just remove slack.
8. Ensure you advise the child not to undo the seat belt buckle unless told to do so.

IN CASE OF ACCIDENT

IN CASE OF ACCIDENT

If your restraint has been involved in a severe crash, you should destroy the restraint even if no damage is obvious. Some insurance companies offer vehicle insurance which covers or partially covers the replacement of your child restraint. Contact your insurance company for further details.

Your insurance company may require you to keep the child restraint for assessment, **but do not use the child restraint after a severe crash.**

AUSTRALIA

Babylove

Phone number: 1300 131 477

NEW ZEALAND

Phone number: 0508 688 822

www.babylove.com.au

info@babylove.com.au

We reserve the right to alter this product without notice in our constant endeavor for improvement.

©2007-2013 Britax Childcare Pty. Ltd.

Babylove, EzyGo Trademarks are the property of Britax Childcare Pty Ltd.

Safe-n-Sound and VERSA-TETHER trademarks are the property of Britax Childcare Pty Ltd.

VERSATETHER Trademark is used by permission of Britax Childcare Pty Ltd.

This product is covered by Australian and Overseas patents and applications.

Patents Pending.

P/No. 2201796/A

