



**IMPORTANT: KEEP THIS BOOKLET IN
THE PLACE PROVIDED ON THE CHILD
RESTRAINT**

EXPANDABLE BOOSTER SEAT

INSTRUCTION BOOK

Series No. BL4200A-020133

baby 
loveTM

SEATBELT QUICK SETUP

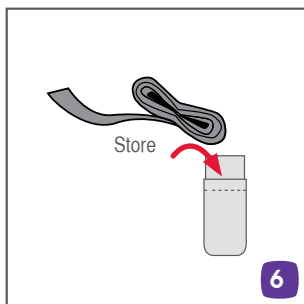
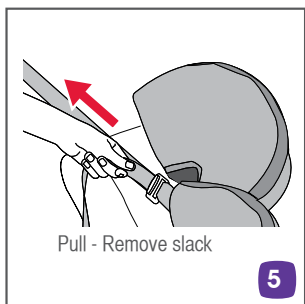
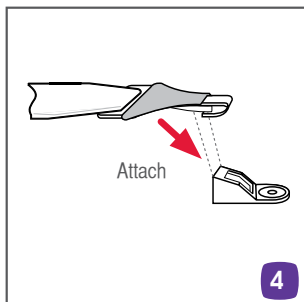
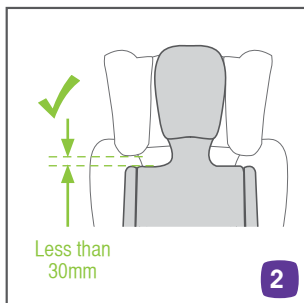
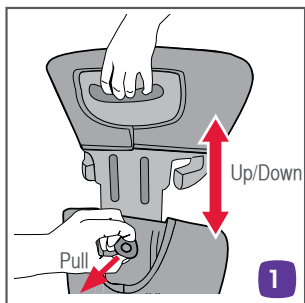

SEATBELT QUICK SETUP

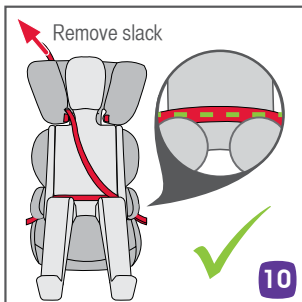
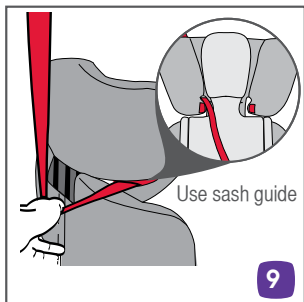
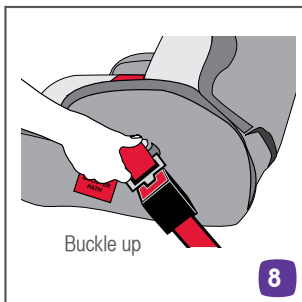
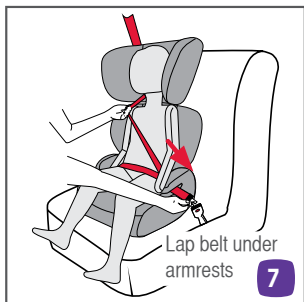

INTRODUCTION

To be used with a lap-sash seatbelt by a child whose shoulders are above the lower shoulder height marker with head restraint in lowest position (approximately 4 years of age) until the child's shoulders reach the upper shoulder height marker with head restraint in highest position (approximately 6 to 8 years of age).

Continue to use this booster seat until the child reaches this limit. Children are safest in a booster seat until their shoulders reach the upper shoulder height marker of the booster seat.

Do not use this restraint until child's shoulders are above the lower shoulder height marker with the head restraint in the lowest position.

If the knees do not bend in front of the vehicle seat cushion continue to use a booster seat.

Just using a seatbelt is not recommended for children that have outgrown this seat. Use a larger booster seat.

يتم استخدامه مع حزام أمان الكتف والخصر للطفل الذي تجاوز كتفيه علامة ارتفاع الأكتاف السفلية في حين وضع حاجز الرأس في أدنى وضعية (تقريباً في عمر 4 سنوات) حتى يصل كتفي الطفل إلى علامة ارتفاع الأكتاف العلوية في حين وضع حاجز الرأس في أعلى وضعية (تقريباً في عمر 6 إلى 8 سنوات).

استمر في استخدام مقعد الأمان المرتفع هذا لحين وصول الطفل إلى هذا الحد. يكون الأطفال أكثر أماناً في مقعد أمان مرتفع حتى تصل أكتافهم إلى علامة ارتفاع الأكتاف العلوية لمقعد الأمان المرتفع.

لا تستخدم مقعد الأمان المرتفع هذا إلا عندما يكون كتفي الطفل أعلى من علامة ارتفاع الأكتاف السفلية في حين وضع حاجز الرأس في أدنى وضعية.

إذا كانت الركبتين لا تنتهيان أمام وسادة كرسي السيارة، استمر في استخدام مقعد أمان مرتفع لا نوصي بمجرد استخدام حزام الأمان للأطفال الذين كبر حجمهم عن هذا المقعد. استخدم مقعد أمان مرتفع ذو مقاس أكبر.

केवल उस शशि द्वारा लेप-सेश सीटबेल्ट के साथ प्रयोग किया जाना चाहिए जिसके कन्धे कन्धे के नचिले भाग से ऊपर आ गए हों (लगभग 4 वर्ष की आयु पर) और तब तक जब तक कि शशि के कन्धे कन्धे के ऊपरी भाग के चनिह तक न पहुँच जाएँ व सरि प्रतबिन्ध सबसे उच्च स्थिति में हो (लगभग 6 से 8 वर्ष की आयु पर)।

बूस्टर सीट को तब तक प्रयोग करते रहें जब तक कि शशि सीमा तक न पहुँचे। शशि बूस्टर सीट में तब तक सबसे अधिक सुरक्षति होते हैं जब तक कि उनके कन्धे बूस्टर सीट के कन्धों के उपरी चनिह तक न पहुँचे।

बूस्टर सीट का प्रयोग तब तक न करें जब तक कि शशि के कन्धे बूस्टर सीट पर कन्धों के नचिले चनिह को पार न करें।

अगर घटने गाडी के सीट के गद्दे पर आगे न मुडें तो बूस्टर सीट का प्रयोग जारी रखें।

INTRODUCTION

肩膀超过靠下肩高标记的儿童需配备安全腰带，头枕放在最低的位置（大约4岁的儿童），直到儿童的肩膀达到靠上的肩高标记，头枕放在最高的位置（大约6-8岁的儿童）。

在儿童达到垫高椅上限之前必须使用垫高椅。在儿童肩膀达到垫高椅靠上的肩高标记之前最安全的做法是使用垫高椅。

在儿童肩膀超过靠下的肩高标记前不得使用该安全座椅，头枕放在最低的位置。

如果儿童在车辆弹性座垫前无法自然屈膝则需要继续使用垫高椅。

不建议个子比该座椅大的儿童只使用安全带，要使用较大的垫高座椅。

Debe utilizarse con un cinturón de seguridad de tres puntos para un niño cuyos hombros sobrepasen el marcador inferior con el reposacabezas en la posición más baja (aproximadamente a los 4 años de edad) hasta que los hombros del niño alcancen el marcador superior con el reposacabezas en la posición más alta (aproximadamente a los 6 a 8 años de edad).

Siga usando este asiento elevador hasta que el niño alcance dicho límite.

El niño estará más seguro en un asiento elevador hasta que sus hombros alcancen el marcador de altura superior del asiento elevador.

No utilice este sistema de seguridad hasta que los hombros del niño no sobrepasen el marcador inferior de con el reposacabezas en la posición más baja.

Si las rodillas del niño no se doblan en la parte delantera del cojín del asiento del vehículo siga utilizando un asiento elevador.

應與安全腰帶一同使用，適用於肩膀超過靠下的肩高標記的孩子（大約4歲大），直至其肩膀達到靠上的肩高標記（大約6至8歲大）。

讓您的孩子一直乘坐墊高椅，直至其達到墊高椅的上限。在孩子肩膀達到墊高椅靠上的肩高度標記之前，使用墊高椅是最安全的做法。

在孩子肩膀超過靠下的肩高標記且其頭部可靠到頭枕的最低位置之前，切勿使用此座椅。

若孩子在汽車座椅邊無法自然曲膝，請繼續使用墊高椅。

孩子因長大超出墊高椅的上限時，不推薦僅僅使用安全帶。請使用更大尺寸的墊高椅。

INTRODUCTION

Na χρησιμοποιείται με μία ζώνη ασφαλείας τριών σημείων από ένα παιδί οι ώμοι του οποίου είναι πάνω από τον κατώτερο δείκτη ύψους ώμου με το προσκέφαλο στη χαμηλότερη θέση (περίπου 4 ετών) μέχρι οι ώμοι του παιδιού να φτάσουν στον ανώτερο δείκτη ύψους ώμου με το προσκέφαλο στην υψηλότερη θέση (περίπου 6 έως 8 ετών).

Συνεχίστε να χρησιμοποιείτε αυτό το βοηθητικό κάθισμα μέχρι το παιδί να φτάσει σε αυτό το όριο. Τα παιδιά είναι ασφαλέστερα σε ένα βοηθητικό κάθισμα μέχρι οι ώμοι τους να φθάνουν στον ανώτερο δείκτη ύψους ώμου του βοηθητικού καθίσματος.

Μην χρησιμοποιείτε αυτή τη διάταξη συγκράτησης μέχρι οι ώμοι του παιδιού να είναι πάνω από τον κατώτερο δείκτη ύψους ώμου με το προσκέφαλο στην χαμηλότερη θέση.

Αν τα γόνατα δεν λυγίζουν μπροστά από το μαξιλάρι καθίσματος του οχήματος, συνεχίστε να χρησιμοποιείτε ένα βοηθητικό κάθισμα.

Η χρήση μόνον μιας ζώνης ασφαλείας δεν συνιστάται για παιδιά που έχουν ξεπεράσει σε ύψος αυτό το κάθισμα. Χρησιμοποιήστε ένα μεγαλύτερο βοηθητικό κάθισμα.

Được sử dụng với dây nịt an toàn quàng qua vai của em nào có vai trên vạch ghi độ cao của vai ở dưới cùng có phần kim đầu ở vị trí thấp nhất (khoảng 4 tuổi) cho đến khi vai của em cao tới vạch ghi độ cao có phần kim đầu ở vị trí cao nhất (khoảng 6-8 tuổi).

Hãy tiếp tục sử dụng ghế trẻ em (booster) này cho đến khi em cao tới giới hạn này. Trẻ em được an toàn nhất trong ghế trẻ em cho đến khi vai của em cao tới vạch ghi độ cao của vai ở trên cùng của ghế trẻ em.

Không sử dụng ghế em bé này cho đến khi vai của em ở trên vạch ghi độ cao của vai ở dưới cùng có phần kim đầu ở vị trí thấp nhất.

Nếu đầu gối không co lại đằng trước đệm ghế xe, hãy tiếp tục sử dụng ghế trẻ em (booster).

INTRODUCTION

Da usare con una cintura di sicurezza fasciante dal bambino le cui spalle sono sopra il marcatore di altezza inferiore con il poggiatesta in posizione più bassa (circa 4 anni di età) fino a quando le spalle del bambino raggiungono il marcatore superiore di altezza con il poggiatesta in posizione più alta (circa 6 a 8 anni di età).

Continuare a utilizzare questo seggiolino fino a quando il bambino raggiunge questo limite. I bambini sono più sicuri su un seggiolino finché le loro spalle raggiungono il marcatore di altezza superiore del seggiolino.

Non utilizzare questo sistema di ritenuta fino a quando le spalle del bambino sono al di sopra del marcatore di altezza inferiore con il poggiatesta nella posizione più bassa.

Se le ginocchia non si piegano al limite del sedile del veicolo continuare ad utilizzare un seggiolino.

Usare soltanto la cintura di sicurezza non è raccomandato per i bambini che sono troppo grandi per questo sedile. Utilizzare un seggiolino più grande.

Gamitin kasama ang isang lap-sash na seatbelt ng isang bata na ang mga balikat ay lampas na sa ibabang marka ng taas ng balikat (humigit-kumulang 4 na taong gulang) hanggang sa maabot ng mga balikat ng bata ang itaas na marka ng taas sa balikat (humigit-kumulang 6-8 taong gulang).

Patuloy na gamitin ang upuang booster na ito hanggang sa maabot ng bata ang limitasyong ito. Ang mga bata ay pinakaligtas sa isang upuang booster hanggang sa maabot ng kanilang mga balikat ang itaas na marka ng taas ng balikat ng upuang booster.

Huwag gamitin ang pampigil na ito hanggang sa ang mga balikat ng bata ay lampas na sa ibabang marka ng taas ng balikat at kung saan ang pampigil ng ulo ay nasa pinakamababang posisyon.

Kung ang mga tuhod ay hindi makaliko sa harap ng kutson ng upuan ng sasakyan ay patuloy na gamitin ang upuang booster.

INTRODUCTION & IMPORTANT INFORMATION

This Booster Seat is designed for use by children from approximately 4 years of age up to approximately 6 to 8 years of age in vehicles using a lap-sash seatbelt. The Booster Seat must not be used with just a lap only seatbelt as the upper body of the child is not protected. It must be used with a lap-sash seatbelt.

A child that is not tall enough to reach the lower shoulder height marker of this booster seat is too small for this Booster Seat the child should continue to use a forward facing fully harnessed child restraint.

This Booster Seat should be used until the child no longer fits in the seat or the child can sit in the car's seat with their lower leg able to hang over the vehicle seat cushion.

This Booster Seat is not designed to be reclined.

CAREFULLY READ ALL THE INSTRUCTIONS FOR INSTALLATION.

IN THE EVENT OF DOUBT ABOUT THE METHOD OF INSTALLATION, CONSULT BABYLOVE OR A CHILD RESTRAINT FITTING STATION AUTHORIZED BY A RELEVANT TRANSPORT AUTHORITY. IN NEW ZEALAND, CONTACT THE AGENT FOR THE VEHICLE.

THIS RESTRAINT MUST BE USED IN CARS WITH FORWARD FACING SEATS WITH A LAP-SASH SEATBELT. THIS BOOSTER IS NOT SUITABLE FOR USE WITH A CHILD HARNESS.

No child restraint can guarantee absolute protection from injury in every crash. However, to ensure that your child gets all the protection designed into the restraint PLEASE READ AND FOLLOW THESE INSTRUCTIONS EXACTLY.

Always store the instruction book in the pocket attached to the back of the cover, for future reference.

PAGE

- 8** INTRODUCTION
- 10** WARNINGS
- 12** SHOULDER HEIGHT MARKERS AND A GROWING CHILD
- 14** FEATURES
- 16** HOW TO SETUP
- 17** HOW TO INSTALL
- 19** HOW TO USE
- 23** HOW TO REMOVE
- 24** CARE AND MAINTENANCE
- 26** ACCESSORIES
- 27** INSTALLATION OF CAR UPPER ANCHORAGE POINT
- 31** IN CASE OF ACCIDENT
- 32** WARRANTY



WARNINGS

- Use the restraint exactly as shown in the instructions.
- Supervision of children is needed because they may be able to undo the buckles and adjusters.
- **DO NOT LEAVE CHILDREN UNATTENDED IN THE CAR.**
- Do not alter or modify this restraint, use only recommended parts and accessories.
- Repairs must only be done by the manufacturer or agent.
- Do not allow the restraint to come into contact with polishes, oils, bleach and other chemicals.
- Destroy the restraint if it has been in a severe crash, even if no damage is visible.
- **DO NOT USE WITH JUST A LAP BELT.** You must use with a lap-sash seatbelt. The lap part of the seatbelt must be firmly across the thighs and the sash belt fitted diagonally across the chest and on the shoulder.
- **DO NOT USE THIS RESTRAINT WITHOUT THE COVER.**
- **IF AN AIRBAG IS FITTED IN THE SEATING POSITION WHERE THE CHILD RESTRAINT IS TO BE FITTED, FOLLOW THE VEHICLE MANUFACTURER'S WARNINGS AND INSTRUCTIONS.**
- Regularly check the restraint components, straps and other fitments for correct function and condition. If faulty, cease using and seek repair by Britax Childcare Pty Ltd.
- This child restraint is not approved for use with any connectors that connect to the car's ISOFIX low anchorages.
- The lap part of the seatbelt must be firmly across the thighs and the sash belt fitted diagonally across the chest and on the shoulder.
- Always secure the loose end of the top tether strap to prevent it hanging out of the car or being accessible by the child. Place excess strap in pocket provided.
- **THIS RESTRAINT IS NOT SUITABLE FOR USE WHERE THE TOP TETHER STRAP MAY FALL INTO A SPLIT IN THE SEAT BACK OR OFF THE SIDE OF THE SEAT.**
- Do not lift the seat by the headrest.



IMPORTANT :

- THIS RESTRAINT MUST BE ATTACHED TO A CHILD RESTRAINT UPPER ANCHORAGE POINT IN THE CAR. REFER TO CAR OWNER'S HANDBOOK FOR LOCATION OF UPPER ANCHORAGE POINTS. REFER TO A CHILD RESTRAINT FITTING STATION IF NO UPPER ANCHORAGE POINTS ARE IN THE MOTOR CAR.
- Protect all webbing from abrasion and cutting by sharp corners and edges.
- This restraint must be used in conjunction with a lap-sash seatbelt.
- Seatbelt extenders are not recommended to be used if the seatbelt is not long enough to secure the child restraint. If seatbelt is too short, seek advice from a child restraint fitter and consider their recommendations before using a seatbelt extender. If you use a seatbelt extender then ensure that the seatbelt buckle does not contact the child.
- Do not travel with the booster seat stored in the front seating position of a vehicle. This may infringe your local Road Rules.
- Regional Road Rules may prohibit the use of a child restraint in the front seat of a car until the child is 4 years of age. Check your Regional Road Rules for exemptions.
- Do not use on any vehicle seat which faces sideways or rearwards.
- Use of aftermarket accessories (i.e. items not provided in the box with the child restraint), can reduce the safety provided by the child restraint and may cause injury or death.
- Do not store in hot places or underneath heavy objects. The plastic may distort.
- The restraint should not be purchased or sold as a second hand item. It is recommended not to use child restraints older than 10 years as the protection may be reduced.

SHOULDER HEIGHT MARKERS & A GROWING CHILD

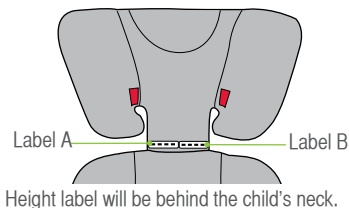

SMALLER CHILD

Shoulders must not be below the Lower Shoulder Height Marker (label A) when the headrest is in the lowest position.

From approximately 4 years of age.

TALLER CHILD

Shoulders must not be above the Upper Shoulder Height Marker (label B) when the headrest is in the highest position.

To approximately 6 to 8 years of age.

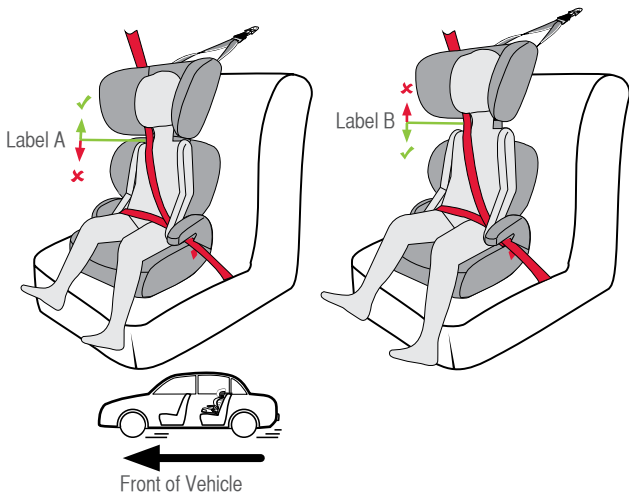

SHOULDER HEIGHT MARKERS & A GROWING CHILD

 **IMPORTANT:** Follow this advice.

Label A:
Smaller Child -
Lower Shoulder
Height Marker

**SHOULDERS ABOVE THIS LINE WHEN
HEADREST AT LOWEST POSITION**



A child who has outgrown their child restraint with in-built harness will have their shoulders in line or above the lowest shoulder height marker (label A) of this booster seat with the headrest in the lowest position. If the child's shoulders are below this marker the child needs to stay in their child restraint with an in-built harness.

Label B:
Larger Child -
Upper Shoulder
Height Marker

**SHOULDERS BELOW THIS LINE WHEN
HEADREST AT HIGHEST POSITION**



The seat can be used until the child's shoulders reaches the top marker (label B) with the headrest fully raised. Usually the shoulder will contact the bottom of the headrest, it is then time to move to the next form of restraint. For maximum safety continue to use this seat as long as the child fits in it.

Next type of restraint that can be used in the car for your child.

When your child has outgrown the expandable booster seat, you can then use either restraint methods as follows:

Use a booster seat suitable for children up to 8-10 years of age with the car's seatbelt, or with a Child Harness suitable for use with the booster seat. For more information on suitable booster seats visit www.babylove.com.au or www.britax.com.au

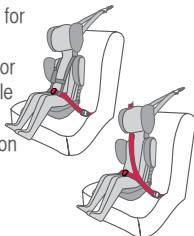

Or the car's lap-sash seatbelt if the lower leg is able to hang over the edge of the seat cushion.

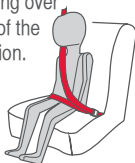

FEATURES

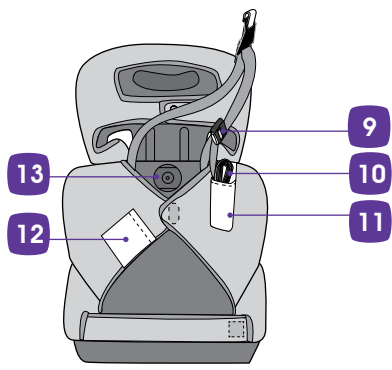
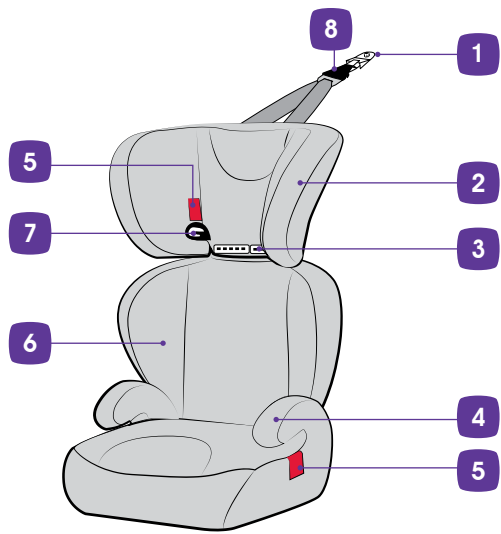

Rear view

1. Vehicle Anchor Fitting
2. Adjustable Height Headrest
3. Shoulder Height Markers
4. Armrest (on each side)
5. Booster Belt Path Label (each side)
6. Padded Cover for Comfort
7. Sash Guide (each side of headrest)
8. Attachment Clip
9. Top Tether Adjuster
10. Adjustable Top Tether Strap
11. Top Tether Storage Pocket (attached to cover)
12. Instruction Manual Pocket (under trim)
13. Headrest Adjustment Knob

HOW TO SETUP

ADJUSTING THE HEADREST

The headrest can be adjusted to different height positions. You will need to remove the seat from the vehicle to adjust the headrest.

To adjust, pull the knob located on the back of the restraint, while raising/lowering the headrest with the other hand.

When adjusting the headrest ensure the bottom of the sash guide is level with or just above your child's shoulder, but not more than 30mm above.

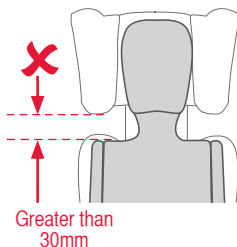
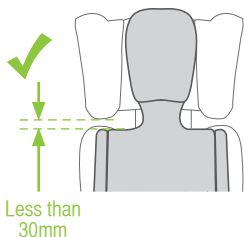
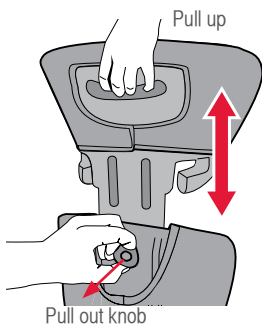

Release the knob and check that the headrest is locked into position by gently pushing down on it.

The headrest position will need to be checked with the child sitting in the seat. If not correct then adjust to the next position and recheck the fit on the child. This adjustment will need to be repeated as the child grows.

HOW TO INSTALL

INSTALLING INTO VEHICLE

Ensure the seating position has a child restraint anchorage fitting available. Refer to your vehicle owner's manual for the location of the upper anchorage point in the car. If the vehicle is not fitted with a child restraint upper anchorage point then refer to page 27 to 30 for the installation of the upper anchorage point provided with this child restraint.

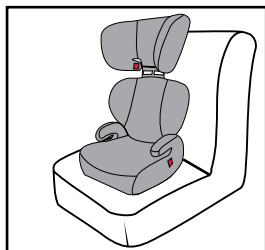

- A. Position the restraint in the car, forward facing, in the chosen seating position. Adjust the headrest to the correct height for your child (refer to page 16). Push the booster against the car seatback.

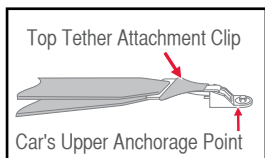

- B. Lengthen the top tether strap and connect the Attachment Clip to the vehicle upper anchorage point, remove all twists.

To lengthen the top tether strap, fully press Adjuster Button (A) while pulling top tether strap (B) to slacken as shown right.

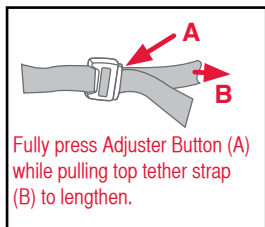

IMPORTANT WARNING:

THE ATTACHMENT CLIP IS FITTED WITH A COVER THAT MUST ALWAYS BE USED. ALWAYS ENSURE THE ATTACHMENT CLIP IS CORRECTLY ENGAGED TO THE UPPER ANCHORAGE POINT AND NOT ATTACHED TO ANY OTHER OBJECT BEFORE EACH USE OF THE RESTRAINT. THIS IS ESPECIALLY IMPORTANT IN VEHICLES SUCH AS STATION WAGONS, VANS OR VEHICLES WITHOUT A FIXED PARCEL SHELF, SINCE THE ANCHOR POINT IS USUALLY NOT VISIBLE.

HOW TO INSTALL

- C. To remove slack from the top tether, pull the adjustable top tether strap **1** and tighten. Do not over-tighten. The restraint base must not lift off the vehicle seat.

Always secure the loose end of the top tether strap in the top there storage pocket **2. Do not use the child restraint where this strap may fall into a split in the seatback or off the side of the seat.**

- D. Roll up excess strap and use the storage pocket on the rear of the cover right hand side to neatly store away from child's reach.

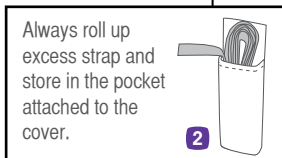
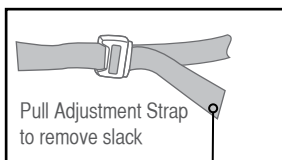
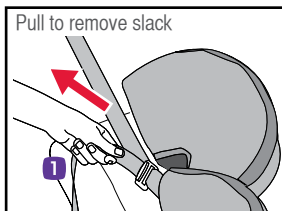

CAUTION:
CHILDREN CAN BE INJURED OR RESTRAINTS AND TOP TETHER STRAP DAMAGED BY UNSECURED CARGO IN A COLLISION. SECURE OR REMOVE HAZARDOUS CARGO BEFORE USING THIS CHILD RESTRAINT.



WARNING

Always attach hook and remove slack.

HOW TO USE

USING LAP-SASH SEATBELT

With the Booster Seat installed in the vehicle as described on the previous page, check the backrest touches the car's seatback and the upper anchorage strap is connected.

Sit your child on the seat. Ensure the headrest is set to the correct height for your child. (See page 16).

Position the lap-sash belt over the child ensuring the lap portion is positioned over the hips and thighs of the child.

Ensure the lap and sash are routed under the armrests following the red seatbelt path labels marked: **BOOSTER SEATBELT PATH 1**.

Engage seatbelt buckle and tongue ensuring there are no twists in the belt. If the seatbelt buckle is adjustable, adjust the buckle as low as possible away from the child.

Fit the sash portion of the belt across the child's chest and through the sash guide (red **BOOSTER SEATBELT PATH** label) on the headrest **2**.

**! IMPORTANT:
ALWAYS USE THIS
SASH GUIDE.**

Red **BOOSTER SEATBELT PATH** Label

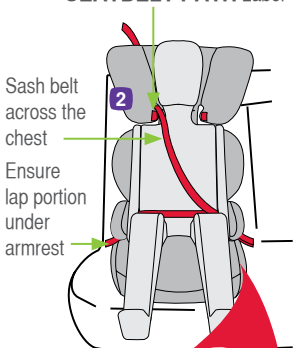

Ensure both lap and sash belts are under the armrest.



Engage buckle **1**

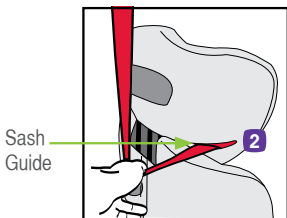

HOW TO USE

Adjust lap and sash portion of seatbelt firmly but comfortably across the child's lap and chest.

Remove all slack.

If using the Inertia Reel Retractor seatbelt, adjust the lap portion of the seatbelt firmly around the child and Booster Seat, feed the slack sash back into the retractor.

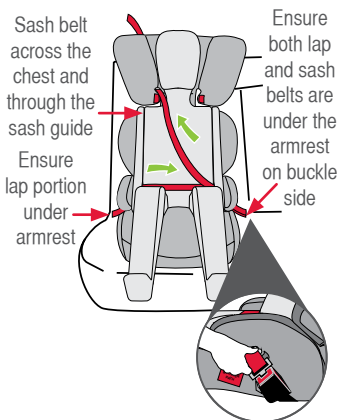

IMPORTANT:

Always ensure the seatbelt is firmly fitted to the hips and thighs and the sash belt is diagonally across the chest and through the sash guide.

The sash must NEVER be under the arm or behind the back of the child.

The child should always sit upright and not slump down.

The lap belt must ALWAYS be firmly on the child's thighs and not on child's abdomen.

A loose or poorly positioned lap belt can allow the lap belt to ride up into the abdomen and can cause serious injuries in a crash.



WARNING:

DO NOT LEAVE CHILDREN UNATTENDED IN THE CAR

! **WARNING** : A sash belt under the arm or behind the back is dangerous.

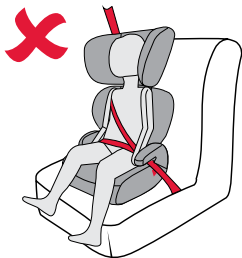

**SEATBELT UNDER
THE ARM IS
DANGEROUS**

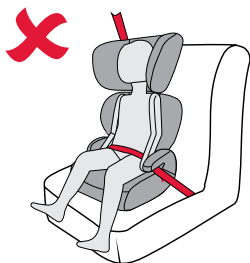

**SEATBELT BEHIND
THE BACK IS
DANGEROUS**

HOW TO USE

SETUP CHECKLIST

Adjust headrest so it is close to the shoulders.
Seatbelt across the chest and through the sash guide.

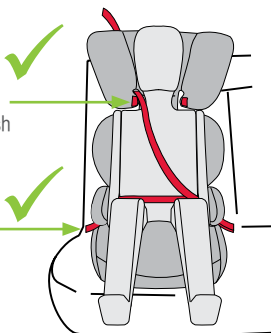

Lap Belt Under Armrests

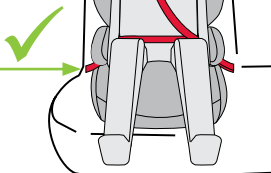

Lap belt must always be firm on the
hips and thighs.
The child must not slump or slouch.

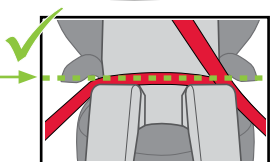

NOTE: Seatbelt extenders should not be used if the seatbelt is not long enough to fit around the child. If a seatbelt extender is used then the seatbelt buckle must not be in contact with the child.

HOW TO REMOVE

TO REMOVE CHILD

Disengage seatbelt tongue and buckle. Remove belt from child. When Booster Seat is not being used, secure in position on the vehicle rear seat by engaging seatbelt over the Booster Seat whilst upper anchorage is attached. Otherwise store booster seat in a safe place.

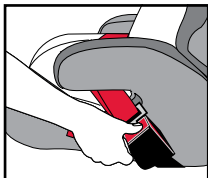

Do not store in the front seat of the vehicle without the upper anchorage attached.

TO REMOVE RESTRAINT FROM VEHICLE

Disconnect the attachment clip from the car whilst lifting the seat slightly to slacken the top tether strap.

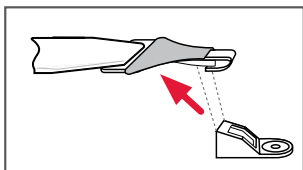

CARE & MAINTENANCE

REGULAR CARE OF THIS RESTRAINT:

Please check the following items regularly to ensure the safety of your child:

- A. Check the top tether strap webbing for fraying.
- B. Ensure there are no cracks in the plastic moulding of the restraint.
- C. If any part of the restraint is cracked or broken, seek repair immediately or replace the child restraint.
- D. Clean the cover and the seat regularly.

HOW TO CLEAN

Use only mild soap and water applied with a moist cloth to clean all metal and plastic parts of the Booster Seat.

Do not use harsh cleaners, polishes, oils, bleach or other chemicals.

COVER

The Booster Seat has a cover made from flame retardant fabric and is removable for cleaning. Washing and care instructions are on the care label attached to the cover. Refer to the following pages for instructions on how to remove and replace the cover.

Connect the hook and loop parts so that the cover is not damaged in the wash.



VERY IMPORTANT:

Only replace the cover with Babylove supplied replacement cover with identical shoulder height markers or a replacement cover meeting AS/NZS 8005.

MAINTENANCE

Other than cleaning, there are no parts on this booster seat that require user maintenance.

CARE & MAINTENANCE

TO REMOVE COVER

Follow the sequence (A to F) below to remove the cover.

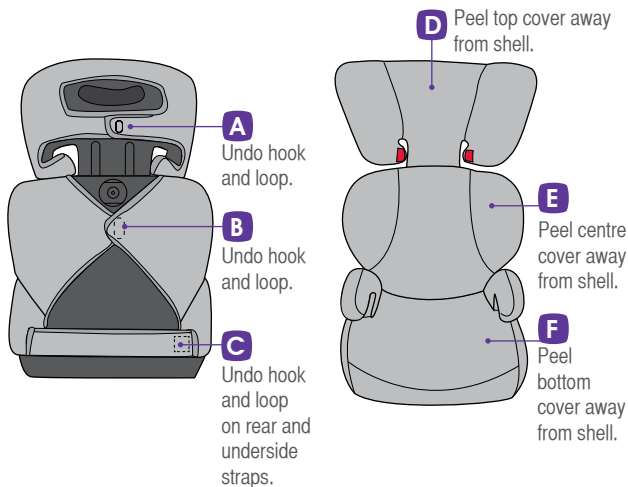

TO REPLACE COVER

- 1** Fit bottom cover on base and re-attach hook and loop straps **C**.
- 2** Align and fit top cover over headrest and headrest impact pad and re-attach hook and loop **A**.
- 3** Align and fit center cover over backrest.
- 4** Re-attach hook and loop **B**.
- 5** Recheck headrest height with your child - refer to page 16.

To refit booster seat in the vehicle - refer to page 17.

ACCESSORIES

Use of aftermarket accessories, (ie items not provided in the box with the child restraint,) that are not Britax Childcare Pty Ltd approved for use with this child restraint can reduce the safety provided by this product and may cause injury or death. Always follow the instructions covering the use of accessories in this booklet or the instructions provided with an accessory. If an aftermarket accessory is used that is not recommended by Babylove, ensure that the accessory is compliant with AS/NZS 8005 and is stated as suitable for use with this child restraint. The following instructions apply to accessories that may be supplied with this restraint at point of purchase. A variety of accessories are available from various retailers of Britax Childcare Pty Ltd products.

CAR INSTALLATION ACCESSORIES

(From retailers of Britax Safe-n-Sound products)

TOP TETHER EXTENSION STRAPS: May be required for cars without a fixed parcel shelf.

Re-order no: 0035 or 0291 (length 300mm)

0036 or 0290 (length 600mm)

INSTALLATION OF CAR UPPER ANCHORAGE POINT

Consult the vehicle owner's handbook for location of anchorage fittings or anchorage points and the possible use of spacers. Some vehicles may have an anchor fitting fitted by the vehicle manufacturer. If anchorage points cannot be found refer to car manufacturer or local child restraint fitting station or traffic authority for optimum position of upper anchorage point and the use of spacers.

Extension Straps

Length 300mm (Use Britax Safe-n-Sound part 0035 or 0291).

Length 600mm (Use Britax Safe-n-Sound part 0036 or 0290).

Available from all major child restraint retailers.

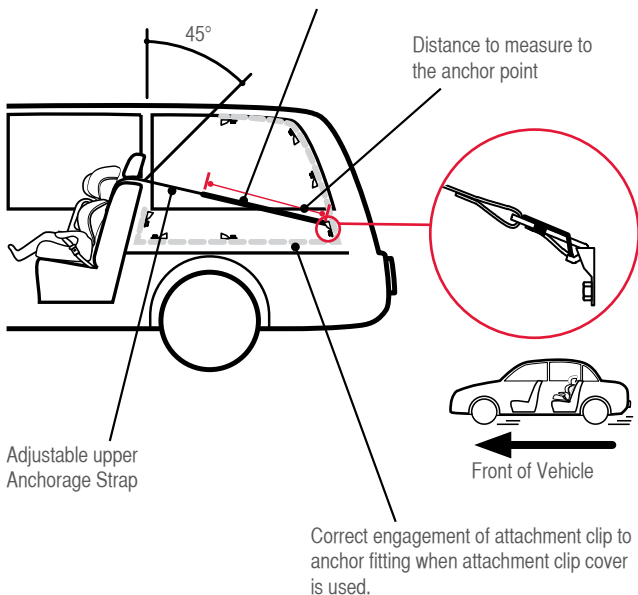

The shaded areas of this diagram illustrate the possible locations of the anchor fitting. Within each shaded area is an anchor fitting showing the correct way to install the fitting. Ensure the anchor fitting is aligned as illustrated unless stated otherwise in the vehicle Owners handbook.

INSTALLATION OF CAR UPPER ANCHORAGE POINT

IF THE CAR IS FITTED WITH CHILD RESTRAINT UPPER ANCHORAGE POINT

Locate the upper anchorage point behind the rear seating position. (Consult the car owners handbook for the location of the upper anchorage point). The upper anchorage point should be directly behind and central to the restraint. Remove thread plug from the parcel shelf/floor/roof, etc. and install attachment bolt and fitting as shown in Fig 1.

CAUTION: DO NOT OVERTIGHTEN ATTACHMENT BOLT.

OVERTIGHTENING MAY FRACTURE OR BREAK BOLT. MAXIMUM TORQUE IS 20 Nm(14.75 ft.lb.)

Note: Minimum of five full turns of attachment bolt is required before tightening force is applied.

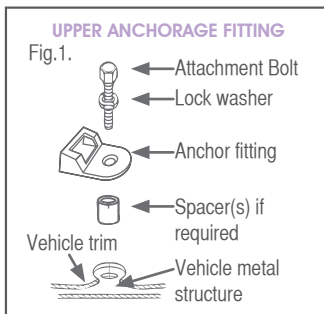

Front of Vehicle

INSTALLATION OF CAR UPPER ANCHORAGE POINT

IF THE CAR IS NOT FITTED WITH CHILD RESTRAINT UPPER ANCHORAGE POINTS

For Sedans only - Drill 9mm diameter hole in the parcel shelf on the centre line of the seating position as shown in Fig 3. Before drilling the hole, check the underside for accessibility. Install the attachment bolt as shown in Fig 2. It is recommended that this installation be carried out by a child restraint fitting station or licenced motor mechanic.

For vehicles other than Sedans - In Australia, consult your nearest child restraint fitting station or traffic authority for vehicle inspection to find the best, correct position for the placement of the upper anchorage point, and for the correct attachment bolt length and use of spacers. In New Zealand, consult the agent for the vehicle. Note to Queensland purchasers: The installation of anchorage points must be approved by authorised officers appointed by Queensland Transport. Authorised officers can be sourced from all Queensland Transport Customer Service and Kidsafe Queensland.

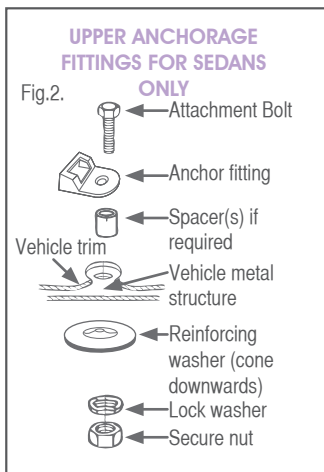

INSTALLATION OF CAR UPPER ANCHORAGE POINT

ONLY USE A 5/16 UNC GRADE 5 BOLT. IF THE BOLT IS NOT THE CORRECT LENGTH THE CAR MANUFACTURER'S HAND BOOK CAN PROVIDE ADVICE ON THE CORRECT LENGTH BOLT.



NOTE: Marking on the top of a Grade 5 Bolt. Do not use any bolt without these marks.



WARNING

CHILD RESTRAINTS MUST NOT BE ATTACHED TO UNSOUND METAL OR TO WOOD, OR SYNTHETIC STRUCTURES. WHEN DRILLING 9 MM HOLE DO NOT DRILL THROUGH FUEL LINES, FUEL TANKS, ELECTRICAL WIRING, OR RADIO SPEAKERS.

WEBBING STRAPS MUST BE PROTECTED FROM SHARP CORNERS AND EDGES. THE ANCHOR FITTING MUST BE USED ONLY AS DESCRIBED ABOVE. IT MUST NOT BE HOOKED ONTO ANY OTHER OBJECT.

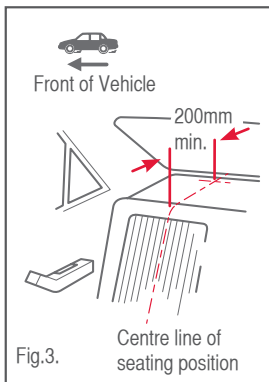

Fig.3.

IN CASE OF ACCIDENT

If your restraint has been involved in a severe crash, you should destroy the restraint even if no damage is obvious. Some insurance companies offer vehicle insurance which covers or partially covers the replacement of your child restraint. Contact your insurance company for further details.

Your insurance company may require you to keep the child restraint for assessment, **but do not use the child restraint after a severe crash.**

WARRANTY

Our goods come with guarantees that cannot be excluded under the Australian Consumer Law. You are entitled to a replacement or refund for a major failure and compensation for any other reasonable foreseeable loss or damage. You are also entitled to have the goods repaired or replaced if the goods fail to be acceptable quality and the failure does not amount to a major failure. For the full terms of the Warranty refer to the Babylove website www.babylove.com.au/warranty

AUSTRALIA

Phone number: 1300 131 477

NEW ZEALAND

Phone number: 0508 688 822

www.babylove.com.au

Britax Childcare Pty Ltd.
A.B.N 55 006 773 600
Level 4, 650 Lorimer Street,
Port Melbourne, Victoria, 3207
Australia

We reserve the right to alter this product without notice in our constant endeavor for improvement.

The Babylove Trademark and model names are the property of Britax Childcare Pty Ltd.

This product is covered by Australian and Overseas patents and applications.

BRITAX Safe-n-Sound
Patents Pending.

©2007-2018

56

baby 
loveTM